

IN-016

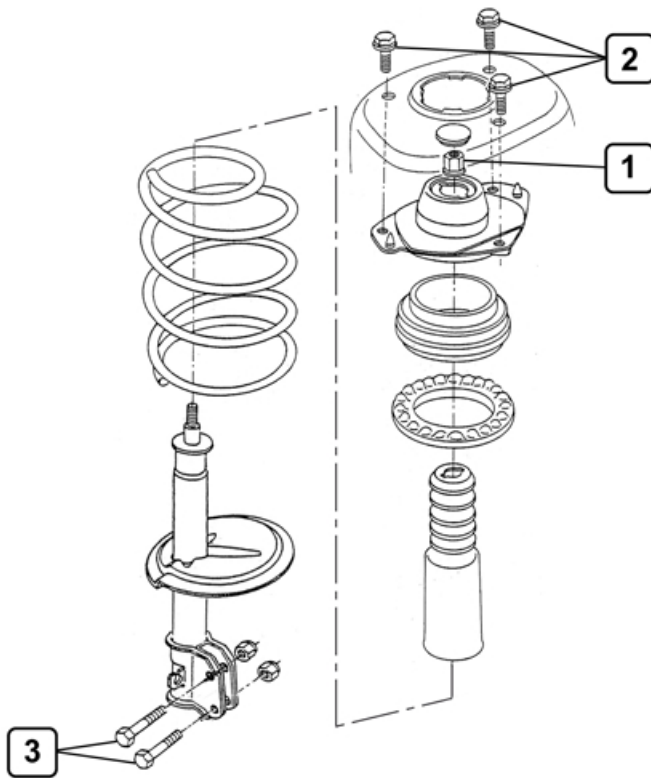

- 1** 100 Nm
- 2** 40 Nm
- 3** 70 Nm



O.E
KYB

