



**Certified Automotive Parts Association**

**Vehicle Test Fit Report**

**Report Number:  
VGGF18FL1 /VTF B/20181025**

**Gordon Auto Body Parts Co., Ltd.**

**Mfr. Part Number: VGGF18FL1**

**New Part Approval (NPA)  
Vehicle Test Fit (VTF) B**

**Date(s) Performed: 2018 October 25 and  
2018 October 30**

**Performed by**

**intertek**

**Intertek - Grand Rapids, US**

This report is for the exclusive use of Intertek's Client and is provided pursuant to the agreement between Intertek and its Client. Intertek's responsibility and liability are limited to the terms and conditions of the agreement. Intertek assumes no liability to any party, other than to the Client in accordance with the agreement, for any loss, expense or damage occasioned by the use of this report. Only the Client is authorized to permit copying or distribution of this report and then only in its entirety. Any use of the Intertek name or one of its marks for the sale or advertisement of the tested material, product or service must first be approved in writing by Intertek. The observations and test results in this report are relevant only to the sample tested. This report itself does not imply that the material, product, or service is or has ever been under an Intertek certification program.

Date: 2018 October 25 and 2018 October 30 Report Number: VGGF18FL1 /VTF B/20181025  
 Manufacturer Part #: VGGF18FL1 Manufacturer: Gordon Auto Body Parts Co., Ltd.  
 Car Company Service Part Application: Volkswagen Golf, 18  
 (CCS) Part #: 5G0821105B

### Summary Page

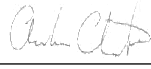
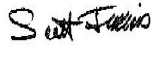
<b>Report Number:</b>	VGGF18FL1 /VTF B/20181025	
<b>Prepared By:</b>	<u>Lauren McCarthy</u>	
<b>Tested By:</b>	<u>Andy Chatel</u> (Printed Name)	 (Signature)
<b>VTF Witnessed:</b>	No	
<b>Reviewed By:</b>	<u>Scott Jenkins</u> (Printed Name)	 (Signature)
<b>Date(s) Test Parts Received:</b>	2018 October 12	
<b>Date(s) of Test:</b>	2018 October 25 and 2018 October 30	
<b>Date of Report Review:</b>	2018 October 31	

<b>Testing Laboratory Name:</b>	Intertek - Grand Rapids, US
<b>Testing Location:</b>	4700 Broadmoor SE, Suite 200, Kentwood, MI 49512

<b>Participant Name and Address:</b>	Gordon Auto Body Parts Co., Ltd., No. 48, Neixi Road, Luzhu District,, Taoyuan City, , Taiwan, 338
--------------------------------------	--

<b>Test Specification Standard:</b>	CAPA Quality Standards Manual (QSM), Appendix J (June 2006)
-------------------------------------	---

Date: 2018 October 25 and 2018 October 30 Report Number: VGGF18FL1 /VTF B/20181025  
 Manufacturer Part #: VGGF18FL1 Manufacturer: Gordon Auto Body Parts Co., Ltd.  
 Car Company Service Part Application: Volkswagen Golf, 18  
 (CCS) Part #: 5G0821105B

### Vehicle Test Fit Summary Page

TEST ITEM DESCRIPTION			
Manufacturer (Mfr.) Part Number:		VGGF18FL1	
Mfr. Part 1 Lot Number:	09/18A	Mfr. Part 2 Lot Number:	09/18A
Car Company Service (CCS) Part Number:		5G0821105B	
Does the CCS part have refrigerant or fluid safety handling labels or markings?			No
Part Type:		Fender L	
Part Application:		Volkswagen Golf, 18	
Vehicle Used:		Volkswagen Golf , 18	
RESULT SUMMARY			
<b>Overall Result:</b>		<b>Conforming</b>	
Fit:		Conforming	
Appearance:		Conforming	
Status of Part Certification:		In-Process	

Date: 2018 October 25 and 2018 October 30      Report Number: VGGF18FL1 /VTF B/20181025  
 Manufacturer Part #: VGGF18FL1      Manufacturer: Gordon Auto Body Parts Co., Ltd.  
 Car Company Service      Part Application: Volkswagen Golf, 18  
 (CCS) Part #: 5G0821105B

<b>DIMENSIONAL (CHECKING FIXTURE) MASTER PART DESIGNATION</b>	
If Mfr. Part 1 and Mfr. Part 2 are both Conforming for Fit, and the CCS Part is Conforming for Fit, then the manufacturer may select any one of the three parts, based on “best fit” if applicable, to be sent to them for Dimensional (Checking Fixture) Master Part designation review.	
If either Mfr. Part 1 or Mfr. Part 2 is Nonconforming for Fit, but the CCS Part is Conforming for Fit, then the CCS Part must be sent to the manufacturer as the Dimensional (Checking Fixture) Master Part.	
<b>TEST PART DISPOSITION</b>	
CCS Part:	Pending Mfr. Advisement
Mfr. Part 1:	Pending Mfr. Advisement
Mfr. Part 2:	Pending Mfr. Advisement
If manufacturer advisement regarding the disposition of the test parts is not provided by the witness when the VTF is performed, then the manufacturer has 15 business days from the date that the report is posted to provide advisement. After 15 business days, Intertek shall dispose of test parts.	

<b>NON-CAPA CERTIFIED PART PACKAGING IDENTIFICATION REQUIREMENTS</b>	
Mfr. Part 1:	Conforming
Mfr. Part 2:	Conforming
Conforming:	Part packaging indicates the part is not CAPA Certified.
Nonconforming:	Part packaging indicates the part is CAPA Certified.
N/A:	Part did not come with packaging.

Date: 2018 October 25 and 2018 October 30      Report Number: VGGF18FL1 /VTF B/20181025  
 Manufacturer Part #: VGGF18FL1      Manufacturer: Gordon Auto Body Parts Co., Ltd.  
 Car Company Service      Part Application: Volkswagen Golf, 18  
 (CCS) Part #: 5G0821105B

### Part Fit Results

<b>CCS Part</b>	Conforming  Motor or actuator present on part? <span style="float: right;">No</span>
<b>Mfr. Part 1</b>	Conforming  Motor or actuator present on part? <span style="float: right;">No</span>
<b>Mfr. Part 2</b>	Conforming  Motor or actuator present on part? <span style="float: right;">No</span>

Date: 2018 October 25 and 2018 October 30 Report Number: VGGF18FL1 /VTF B/20181025  
Manufacturer Part #: VGGF18FL1 Manufacturer: Gordon Auto Body Parts Co., Ltd.  
Car Company Service Part Application: Volkswagen Golf, 18  
(CCS) Part #: 5G0821105B

### Part Fit Results

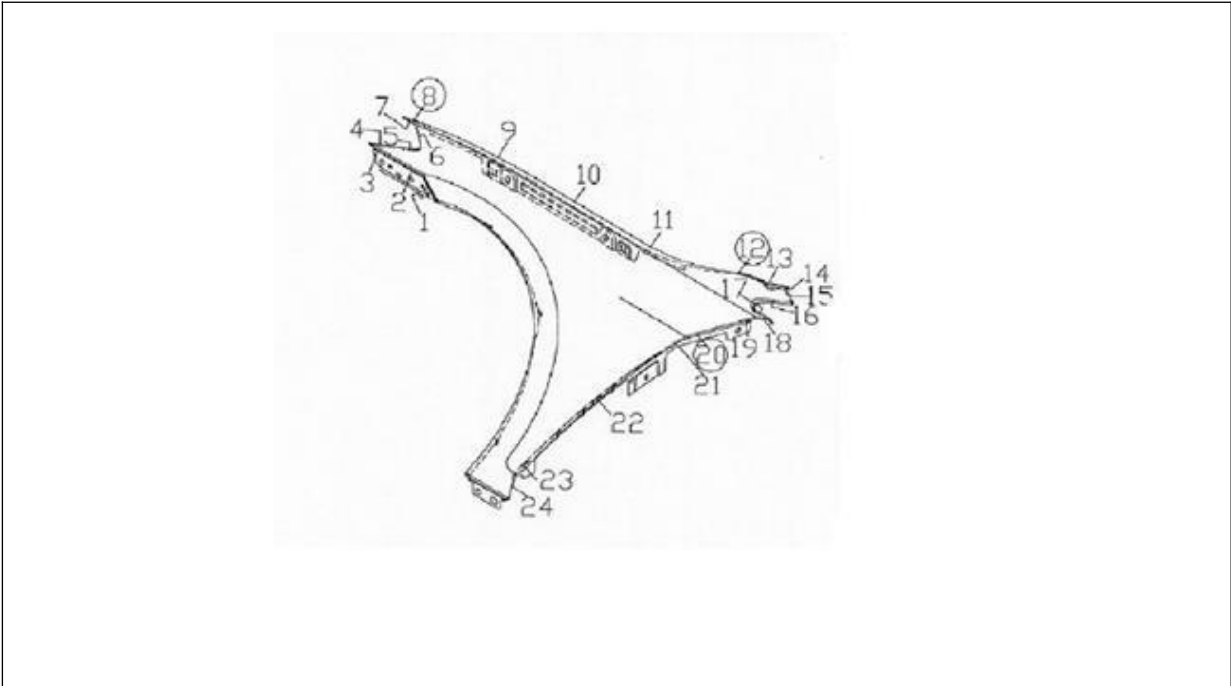

Date: 2018 October 25 and 2018 October 30 Report Number: VGGF18FL1 /VTF B/20181025  
 Manufacturer Part #: VGGF18FL1 Manufacturer: Gordon Auto Body Parts Co., Ltd.  
 Car Company Service (CCS) Part #: 5G0821105B Part Application: Volkswagen Golf, 18

**Vehicle Test Fit Dimensional Data (mm)**

<b>GAP</b>				
	<b>CCO Part</b>	<b>Mfr. Part 1</b>	<b>Mfr. Part 2</b>	<b>CCS Part</b>
1				
2				
3				
4				
5				
6				
7				
8	<b>3.1</b>	<b>3.6</b>	<b>3.8</b>	<b>3.3</b>
9	<b>3.7</b>	<b>3.8</b>	<b>4.1</b>	<b>3.7</b>
10	<b>3.5</b>	<b>3.7</b>	<b>3.7</b>	<b>3.9</b>
11	<b>3.1</b>	<b>3.6</b>	<b>3.5</b>	<b>3.4</b>
12	<b>3.6</b>	<b>3.9</b>	<b>3.8</b>	<b>3.5</b>
13				
14	<b>2.3</b>	<b>2.4</b>	<b>2.0</b>	<b>2.4</b>
15	<b>2.4</b>	<b>2.4</b>	<b>2.1</b>	<b>2.3</b>
16				
17				
18	<b>3.2</b>	<b>3.7</b>	<b>3.8</b>	<b>3.6</b>
19	<b>3.3</b>	<b>3.6</b>	<b>3.7</b>	<b>3.5</b>
20	<b>3.7</b>	<b>4.1</b>	<b>4.0</b>	<b>4.0</b>
21	<b>4.1</b>	<b>4.4</b>	<b>4.1</b>	<b>4.3</b>
22	<b>4.1</b>	<b>4.5</b>	<b>4.0</b>	<b>4.4</b>
23	<b>4.2</b>	<b>4.4</b>	<b>3.8</b>	<b>4.5</b>
24	<b>4.1</b>	<b>4.5</b>	<b>3.8</b>	<b>4.6</b>

/: Due to the fit of the test part against the adjacent part(s), a gap and/or flush measurement could not be taken at this point.

Car Company Original (CCO) Part: Assembly part installed at the factory.  
 Car Company Service (CCS) Part: Car company brand replacement part.  
 Manufacturer (MFR) Part: Replacement part produced by a CAPA Participant that is in the CAPA Certification process.

Date: 2018 October 25 and 2018 October 30 Report Number: VGGF18FL1 /VTF B/20181025  
 Manufacturer Part #: VGGF18FL1 Manufacturer: Gordon Auto Body Parts Co., Ltd.  
 Car Company Service (CCS) Part #: 5G0821105B Part Application: Volkswagen Golf, 18

**Vehicle Test Fit Dimensional Data (mm)**

FLUSH				
	CCO Part	Mfr. Part 1	Mfr. Part 2	CCS Part
1				
2				
3				
4				
5				
6				
7				
8	<b>0.2</b>	<b>0.4</b>	<b>-0.1</b>	<b>0.4</b>
9	<b>0.4</b>	<b>-0.1</b>	<b>0.2</b>	<b>-0.4</b>
10	<b>-0.3</b>	<b>-0.8</b>	<b>-0.9</b>	<b>-1.1</b>
11	<b>-0.2</b>	<b>-0.5</b>	<b>-0.5</b>	<b>-0.5</b>
12	<b>-0.5</b>	<b>0.3</b>	<b>0.2</b>	<b>-0.2</b>
13				
14	<b>0.1</b>	<b>0.9</b>	<b>0.6</b>	<b>0.4</b>
15	<b>0.0</b>	<b>-0.4</b>	<b>-0.7</b>	<b>0.3</b>
16				
17				
18	<b>0.8</b>	<b>0.2</b>	<b>0.7</b>	<b>1.0</b>
19	<b>0.6</b>	<b>0.7</b>	<b>1.1</b>	<b>0.6</b>
20	<b>1.2</b>	<b>0.9</b>	<b>1.4</b>	<b>0.8</b>
21	<b>0.6</b>	<b>0.4</b>	<b>0.8</b>	<b>0.2</b>
22	<b>0.3</b>	<b>0.2</b>	<b>0.3</b>	<b>0.4</b>
23	<b>0.2</b>	<b>0.1</b>	<b>0.5</b>	<b>0.2</b>
24	<b>0.1</b>	<b>-0.4</b>	<b>0.3</b>	<b>0.0</b>

/: Due to the fit of the test part against the adjacent part(s), a gap and/or flush measurement could not be taken at this point.

Car Company Original (CCO) Part: Assembly part installed at the factory.  
 Car Company Service (CCS) Part: Car company brand replacement part.  
 Manufacturer (MFR) Part: Replacement part produced by a CAPA Participant that is in the CAPA Certification process.



Date: 2018 October 25 and 2018 October 30 Report Number: VGGF18FL1 /VTF B/20181025  
 Manufacturer Part #: VGGF18FL1 Manufacturer: Gordon Auto Body Parts Co., Ltd.  
 Car Company Service (CCS) Part #: 5G0821105B Part Application: Volkswagen Golf, 18

### Vehicle Test Fit Dimensional Data Plot

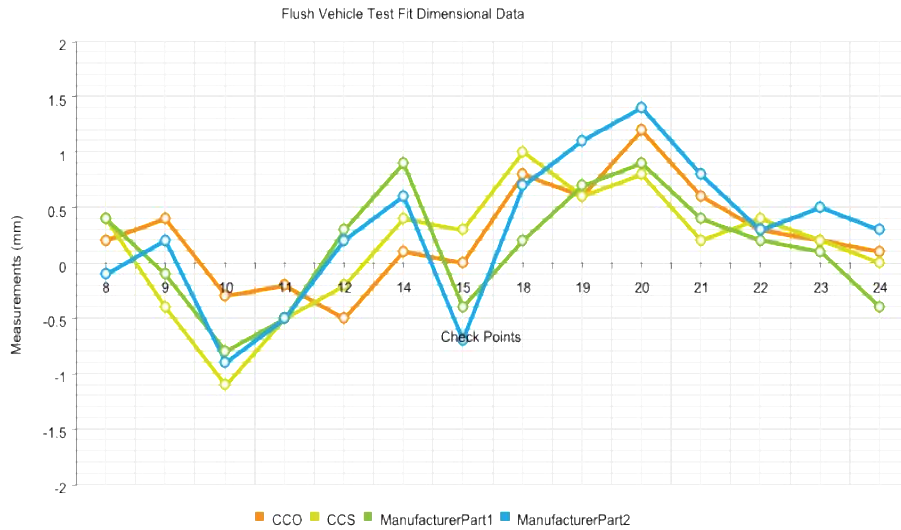
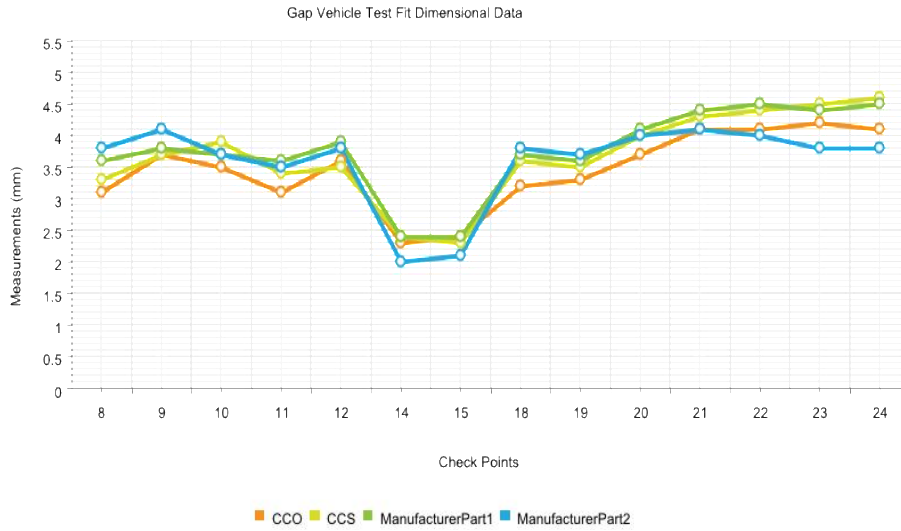

Date: 2018 October 25 and 2018 October 30      Report Number: VGGF18FL1 /VTF B/20181025  
 Manufacturer Part #: VGGF18FL1      Manufacturer: Gordon Auto Body Parts Co., Ltd.  
 Car Company Service      Part Application: Volkswagen Golf, 18  
 (CCS) Part #: 5G0821105B

### Identification of Features - Fender L

Hole number for recommended Primary Mounting Hole:	10
Hole number for recommended Secondary Mounting Hole:	7

Are all necessary features identified on the Inspection Instructions?	No
---	----

If No, identify additional holes/features in the table below.



Feature No	Feature Function
20	Fender Mounting

**The information on this page applies to the vehicle used for the evaluation. This information is not intended to represent all vehicle applications to which the CCS part number may apply.**

Date: 2018 October 25 and 2018 October 30 Report Number: VGGF18FL1 /VTF B/20181025  
 Manufacturer Part #: VGGF18FL1 Manufacturer: Gordon Auto Body Parts Co., Ltd.  
 Car Company Service Part Application: Volkswagen Golf, 18  
 (CCS) Part #: 5G0821105B

### Part Appearance Inspection Results

Appearance Conditions											
A	Burrs	F	Ripples	K	Chips	P	Dirt/Foreign Material	U	Rough Surface	SD	Shipping Damage (Specify type with letter code above or describe if Other)
B	Distortion	G	Rolled Edges	L	Dents	Q	Non-Uniform Coating Coverage	V	Wet Mar		
C	Excess Material	H	Tool Marks	M	Dings	R	Orange Peel	W	Adhesive (Describe below)		
D	Metal Folds	I	Waviness	N	Grind Marks	S	Pits	X	Welds (Describe below)		
E	Radius	J	Bumps	O	Scratches/ Gouges	T	Rinse Residue	Y	Other (Describe below)		

<b>CCS Part</b>	Conforming	Foam rubber present on part: No		
	Conforming			
	Conforming			

Date: 2018 October 25 and 2018 October 30 Report Number: VGGF18FL1 /VTF B/20181025  
Manufacturer Part #: VGGF18FL1 Manufacturer: Gordon Auto Body Parts Co., Ltd.  
Car Company Service Part Application: Volkswagen Golf, 18  
(CCS) Part #: 5G0821105B

### VTF Photos



Date: 2018 October 25 and 2018 October 30 Report Number: VGGF18FL1 /VTF B/20181025  
 Manufacturer Part #: VGGF18FL1 Manufacturer: Gordon Auto Body Parts Co., Ltd.  
 Car Company Service Part Application: Volkswagen Golf, 18  
 (CCS) Part #: 5G0821105B

## CAPA QSM Appearance Inspection Criteria (101) – Rev 03/2008

### 10.2.1 General Appearance/Visual Non-Conformance Classifications

The following visual conditions will be considered unacceptable.

<i>Visual Conditions</i>	<i>Definition</i>
Burrs	Small pieces of metal with sharp edges that could lacerate the skin during handling. (Class A, B, C)
Distortion	Visible variations on the surface and formed edges such as bodylines, folds, or bends. Includes edge roughness, edge contour, edge consistency and edge radius. (Class A)
Excess Material	Edges not trimmed in the same manner as the OEM Master Part. Seen as “flash” on plastic parts or in cowl areas, fender folds at door lines, mounting flanges, and hood corners. (Class A, B, C)
Metal Folds	Edges not crimped in the same manner as those on the OEM Master Part. (Class B, C)
Radius	Rounded corners and trim line form inconsistent with those of the OEM Master Part. Corners lacking material creating a hole; sharp corners resulting from excess material or poor grinding operations. Opposite corners having differently shaped radii. (Class A, B, C)
Ripples	Visible variations on the part surface and formed edges such as bodylines, folds, or bends. Includes edge roughness, edge contour, edge consistency and edge radius. (Class A)
Rolled Edges	Upward bulge typically seen along the edge to the part or where metal forms a bodyline. Observed at hood edges, fender-to-door -line, fender cowl area, and top fender-to-hood edge. (Class A)
Tool Marks	Cuts in the surface material that can be felt with the back of a fingernail. (Class A)
Waviness	Visible variations on the part surface and formed edges such as bodylines, folds, or bends. Includes edge roughness, edge contour, edge consistency and edge radius.

### 10.2.2 General Finish/Visual Non-Conformance Classifications

The following finish conditions will be considered unacceptable.

<i>Finish Conditions</i>	<i>Definitions</i>
Bumps	Localized depressions or protrusions that can be felt with the back of a fingernail. (Class A)
Chips	A small portion of missing primer or coating, usually caused by scraping or hitting the primer or coating surface, leaving bare metal. (Class A, B, C)
Dents	Localized depressions or protrusions that can be felt with the back of a fingernail. (Class A)
Dings	Localized depressions or protrusions in the metal or substrate that are visible after priming or coating. (Class A)
Grind Marks	Cuts in the surface material that can be felt with the back of a fingernail. (Class A)
Scratches / Gouges	Marks in the surface that can be felt with the back of a fingernail. (Class A, B, C)
<i>EDP Finish Conditions</i>	
Dirt / Foreign Material	Small particles in the EDP coat part surface that can be felt with the back of the fingernail. (Class A)
Non-Uniform Coating	Inconsistencies on the EDP coating such as blisters, missing or thin EDP, or drip

Date: 2018 October 25 and 2018 October 30      Report Number: VGGF18FL1 /VTF B/20181025  
 Manufacturer Part #: VGGF18FL1      Manufacturer: Gordon Auto Body Parts Co., Ltd.  
 Car Company Service (CCS) Part #: 5G0821105B      Part Application: Volkswagen Golf, 18

Coverage	marks due to hanging that can be felt with the back of the fingernail. (Class A)
Orange Peel	Rippled or wavy EDP coating on the part surface that can be felt with the back of the fingernail. (Class A)
Pits	Small porous holes in the EDP coat on the part surface. (Class A, B, C)
Rinse Residue	Visually detected Streaking marks or discoloration left after the EDP process. (Class A)
Rough Surface	Inconsistencies on the surface that can be felt with the back of a fingernail. (Class A)
Wet Mar	Smearred EDP coat due to packaging prior to coat being fully dry or cured. (Class A, B, C)

**10.2.3 General Performance Appearance/Visual Non-Conformance Classifications**

The following performance will be considered unacceptable.

Performance Conditions	Definitions
<i>Adhesive Performance Conditions</i>	
Incorrect Placement	Adhesive that are not in correct placement may create distortion to the Class "A" surface (pull down).
Low Coverage	Adhesive that lack area coverage may pull apart.
Missing Adhesive	Adhesive areas that are not present but present on OEM master part.
<i>Weld Performance Conditions</i>	
Missing Welds	Welds that are not present but present on OEM Master.
Weld Burn	Welds that burn through or distort the Class "A" Surface.

**10.10 Refrigerant and Fluid Safety or Handling Labels or Markings**

In the event that the CCS Material Test Part provides associated safety or handling labels or markings, the CAPA Sample Part must provide safety and handling labels and markings that are comparable in color, graphical display, legibility, font format, font size, and durability.