

Assembly instruction for fuel pumps

Einbauhinweise für Kraftstoffpumpen
Instrucciones de montaje para bombas de combustible
Instructions de montage pour pompes à carburant
Инструкция по установке топливных насосов
Istruzioni di montaggio per pompe carburante



**Installation by qualified personnel only.
Car manufacturer's instructions to be
observed closely.**

Einbau nur durch geschulte Fachkräfte. Hinweise der Fahrzeughersteller genau befolgen.

El montaje sólo debe realizarse por un técnico instruido. Siga exactamente las indicaciones del fabricante del vehículo.

Installation uniquement par main-d'oeuvre spécialisée. Suivre les indications du fabricant d'automobile pour l'installation.

Монтаж должны производить только обученные специалисты. Следует точно соблюдать инструкции завода-изготовителя автомобиля.

Montaggio solo da parte di meccanici specializzati. Sono da seguire esattamente le istruzioni fornite dal costruttore del veicolo.

1



2

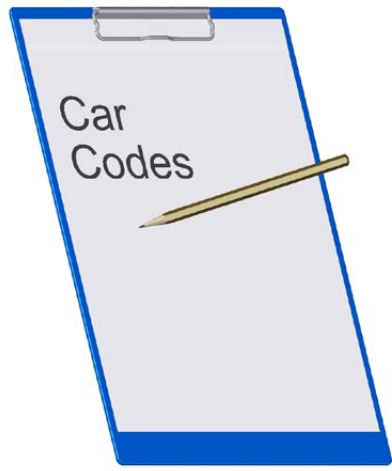

3

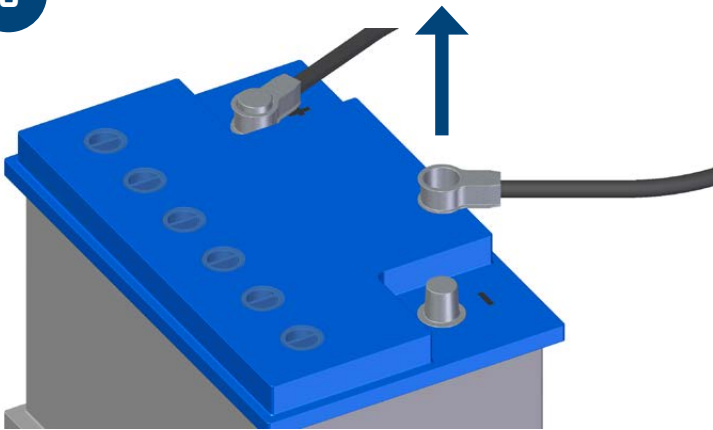

4



5

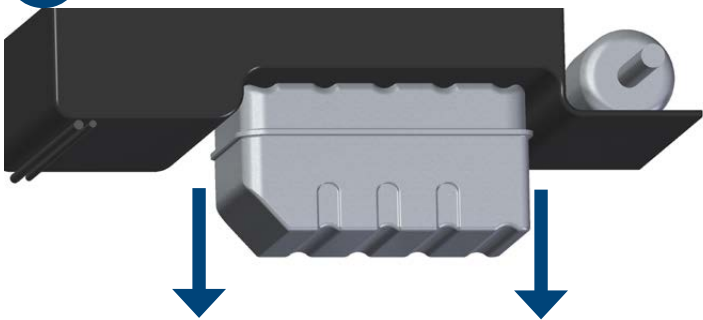

if necessary

6

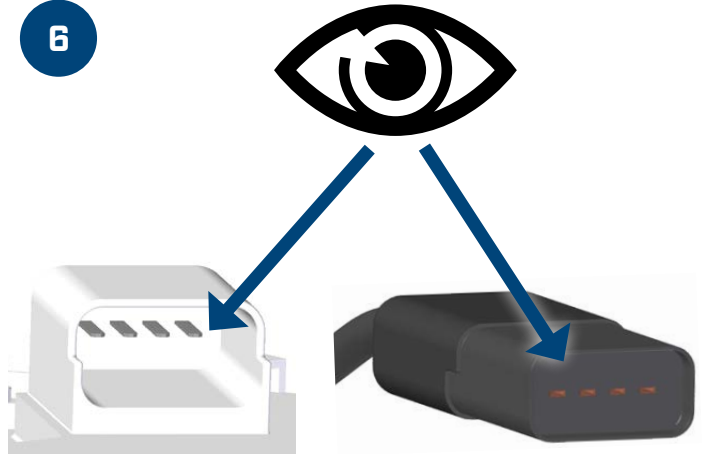

7

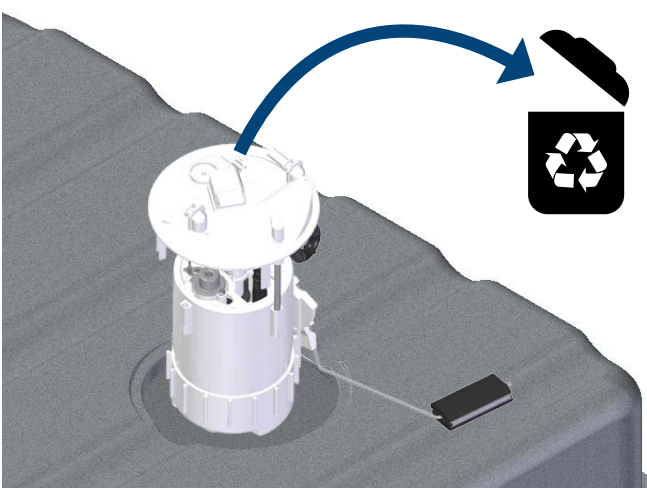

8

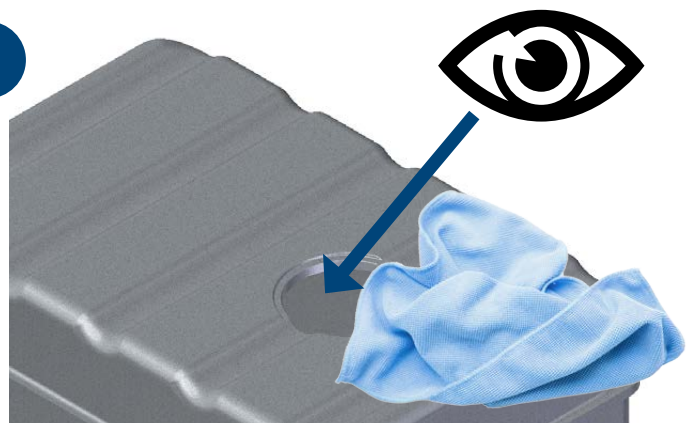

9



NEW

10

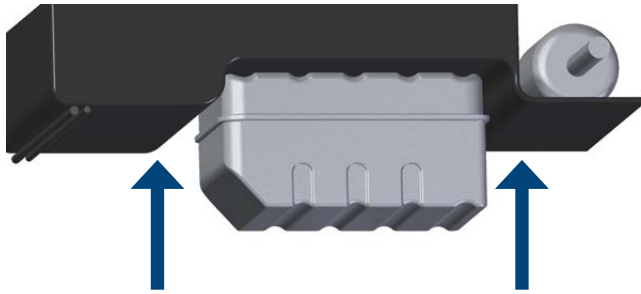

if necessary

11



NEW

12

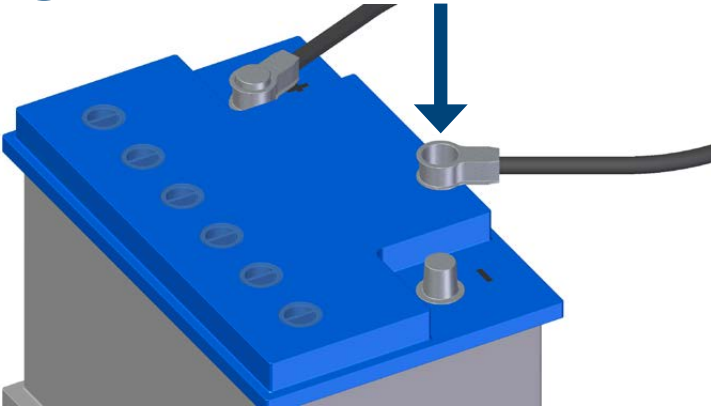

13



14

