

Hella Optisches Warn-System OWS • Hella OWS Visual Warning System

Technisches Handbuch • Technical Manual



© Hella KGaA Hueck & Co. D-59552 Lippstadt



460 839-00/12/00

Hella Optisches Warn-System OWS

Technisches Handbuch

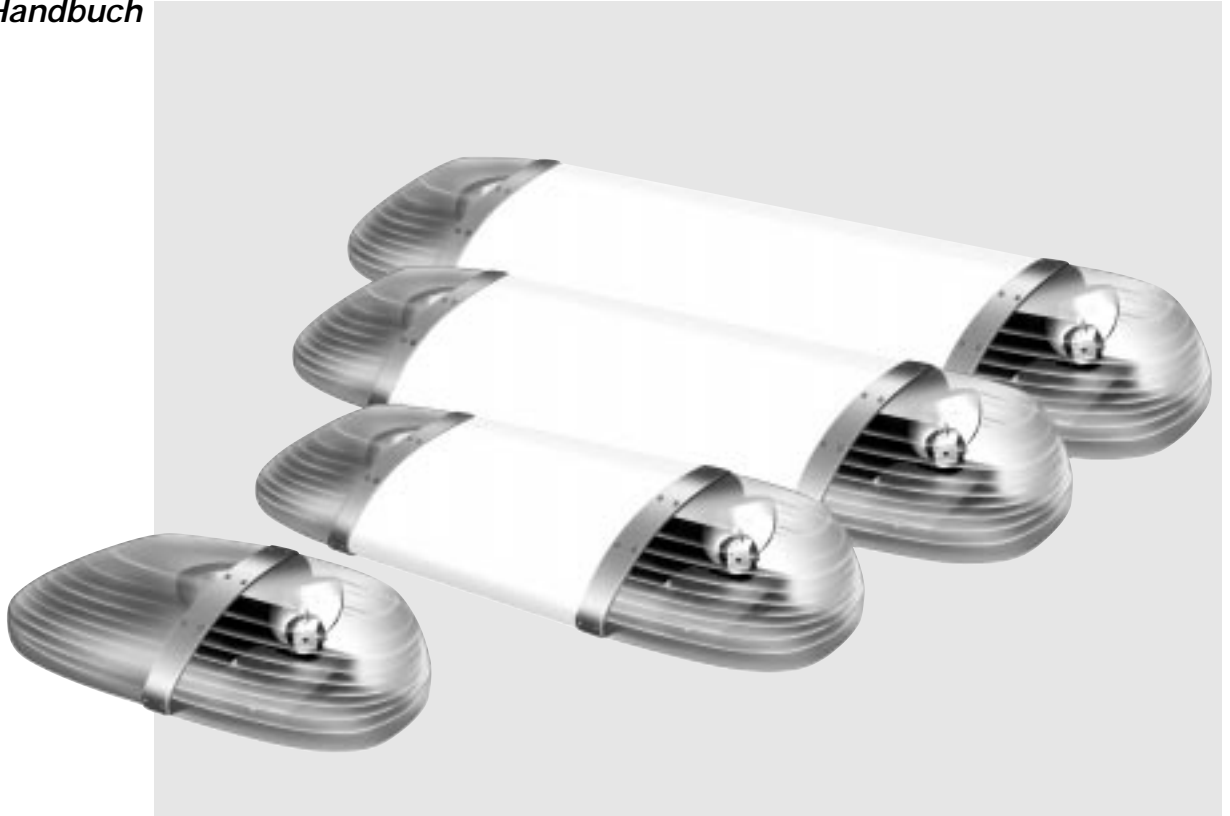

Lesen Sie vor Montagebeginn diese Montage- und Bedienungsanleitung ganz durch und beachten Sie die Reihenfolge der Montageschritte ganz genau. Eine nicht sachgerechte Montage kann die Betriebssicherheit Ihres Fahrzeuges gefährden.

(D)	<i>Deutsch</i>	Seite	3 – 20
(GB)	<i>English</i>	Page	21 – 40
(F)	<i>Français</i>	Page	41 – 60
(S)	<i>Svenska</i>	Sidan	61 – 80
(NL)	<i>Nederlands</i>	Pagina	81 – 100
(E)	<i>Español</i>	Página	101 – 120
(I)	<i>Italiano</i>	Pagina	121 – 140
(FIN)	<i>Suomi</i>	Sivu	141 – 160

Technisches Handbuch

Hella Optisches Warn-System OWS

Inhaltsverzeichnis

	Seite
1.0 <i>Allgemeine Information</i>	4
2.0 <i>Montage</i>	6
3.0 <i>Elektrischer Anschluß</i>	12
4.0 <i>Technische Daten</i>	13
5.0 <i>Geräteabarten / Ersatzteile</i>	14
6.0 <i>Zubehör</i>	15
7.0 <i>Fehlersuche</i>	19

1.0 Allgemeine Information

System und Funktionen

Das Hella OWS ist ein Kompaktsystem für öffentliche Straßendienst-Kraftfahrzeuge,

Pannenhilfsdienste, Kraftfahrzeuge mit Überlänge oder Überbreite, mit gelben Rundum-Kennleuchten und einer von innen beleuchtbaren

Werbefläche für individuelle Beschriftung.

Das Hella OWS besteht aus den Systemteilen:

- Kennleuchten gelb, (zwei 360°-Rundum-Kennleuchten mit rotierendem Reflektor und H1-Halogen-Glühlampen).
- Werbefläche für Beschriftung als Nachrüstung von innen beleuchtbar (fünf bzw. zehn parallel geschaltete Glühlampen)*

*) Der von innen beleuchtbare Schriftzug ist im Typenprüfbereich der StVZO sowie in Österreich und der Schweiz nicht erlaubt.

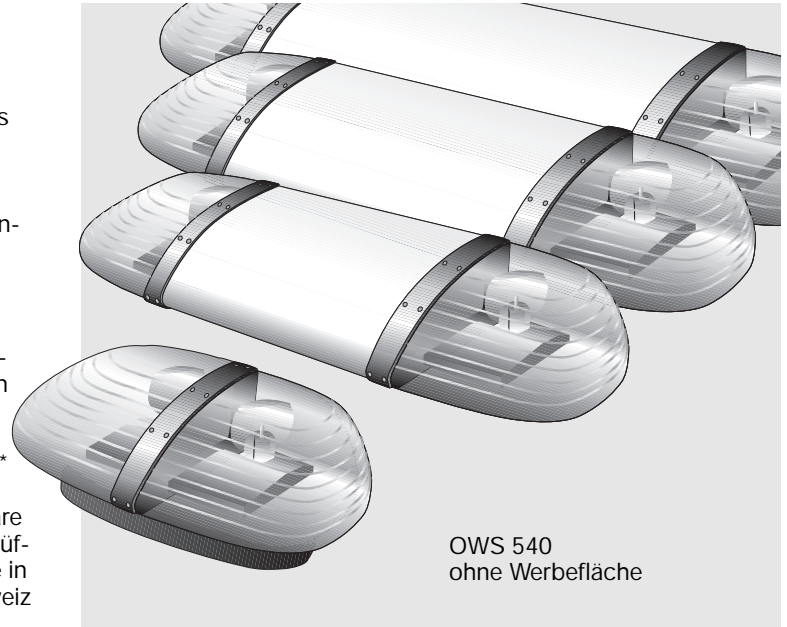

OWS 540
ohne Werbefläche

Vielseitig einsetzbar

So vielseitig wie die Einsatzmöglichkeiten des OWS sind, so vielseitig kann auch die Beschriftung sein.

Die großflächigen Lichtscheiben geben Ihnen vielfältige Möglichkeiten der Beschriftung.

Die vordere und die hintere Blende lassen sich problemlos mit der Kennzeichnung Ihrer Wahl bedrucken.

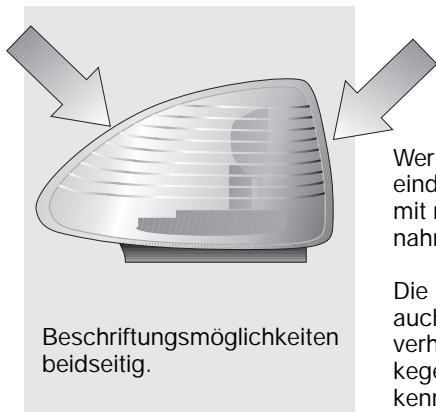

Beschriftungsmöglichkeiten beidseitig.

Wer sein Einsatzfahrzeug eindeutig kennzeichnet, kann mit noch mehr Rücksichtnahme rechnen.

Die Kennzeichnung bleibt auch bei schlechten Wetterverhältnissen in den Lichtkegeln der beiden Rundumkennleuchten erkennbar.

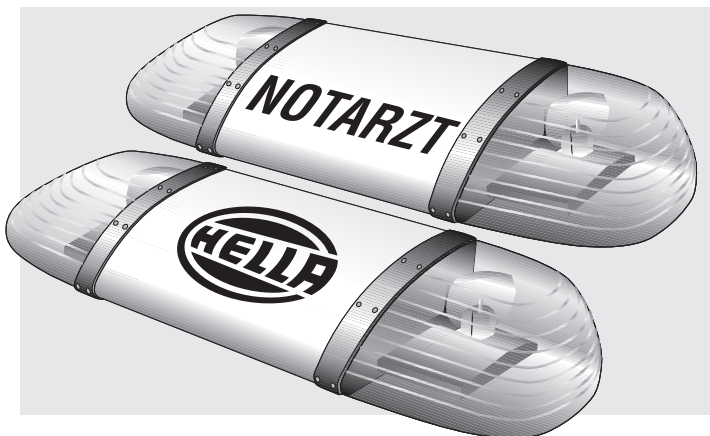
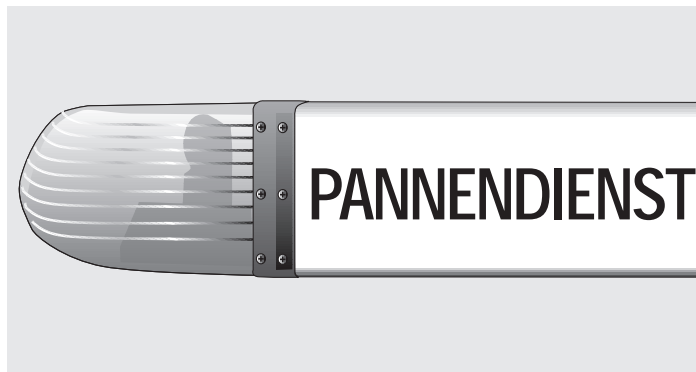

2.0 Montage

Vor Montagebeginn mit dem Fahrzeughersteller klären, ob eine Dachverstärkung notwendig ist.

Ebenen Anbauort auf dem Fahrzeugdach festlegen und je nach Montageart die Befestigung vorbereiten.

Achtung:

Nach jeder Montage und vor jedem Fahrtritt ist die Anlage auf einwandfreien Sitz und festsitzende Spannverbindungen zu prüfen.

2.1 Festmontage

Anhand der Maßzeichnung die Umrisse der ausgerichteten OWS auf dem Fahrzeugdach markieren. Hierbei ist die Dachwölbung zu beachten.

Deckenverkleidung im Fahrzeuginnenraum öffnen. Bohrungen entsprechend der Maßzeichnung bohren. Vorbereitete Anschlußleitung durch die Kabelöffnung führen.

Die Dachauflagefläche des Fahrzeugs muß frei von Schnee, Eis und Schmutz sein.

Achten Sie vor dem Bohren darauf, daß darunterliegende Fahrzeugteile nicht beschädigt werden.

Wir empfehlen, in Metall gebohrte Löcher mit Rostschutz zu versiegeln. Kabeldurchführungsöffnung nach Montage mit einem Dichtkleber verschließen.

Bohrschablone
OWS 540

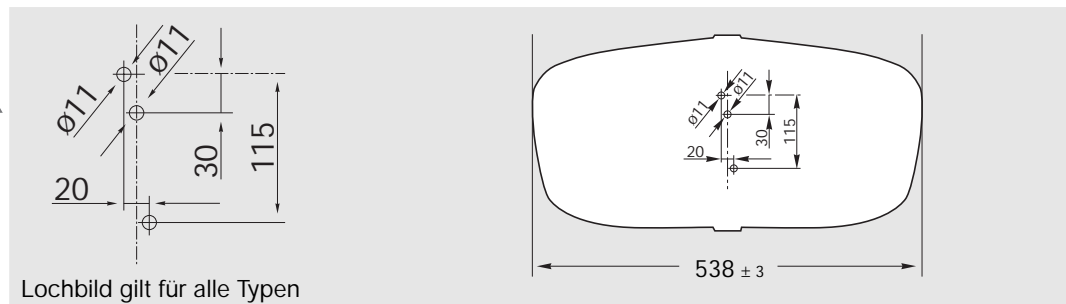

Bohrschablone
OWS 1000

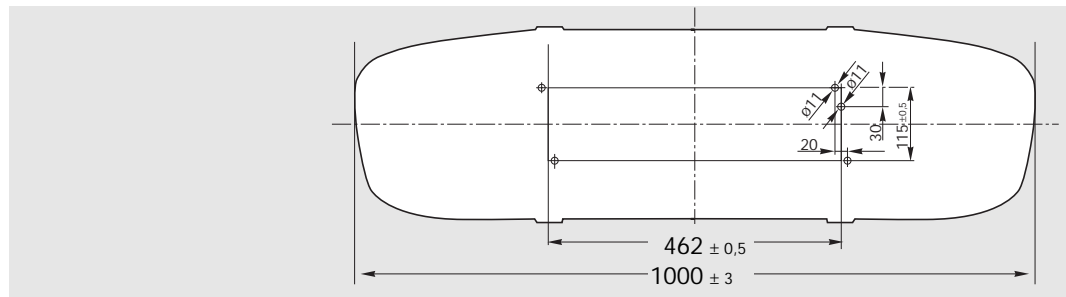

Bohrschablone
OWS 1400

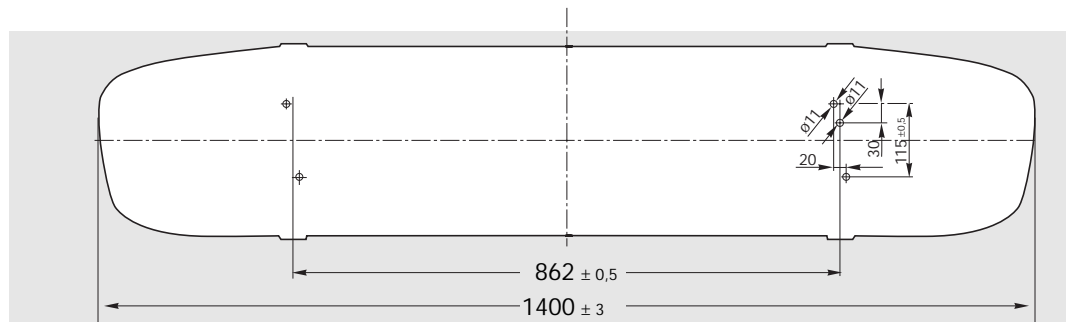

Bohrschablone
OWS 1600

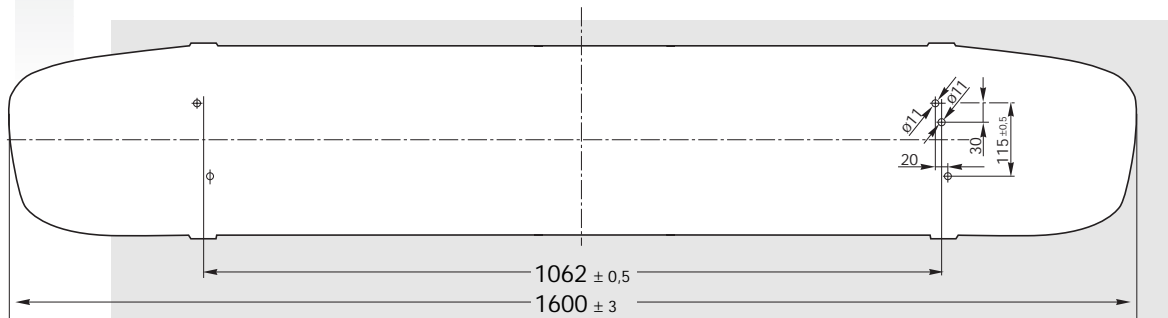

Montage

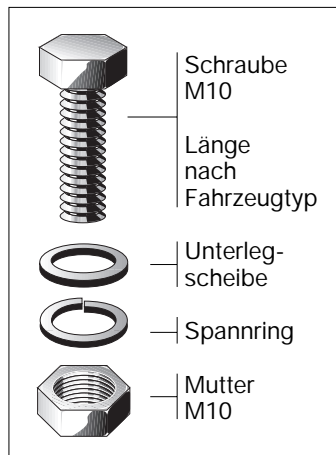

Befestigungsmaterial gehört nicht zum Lieferumfang.

Befestigungsschrauben
M10

Max. Anzugsdrehmoment
4 Nm

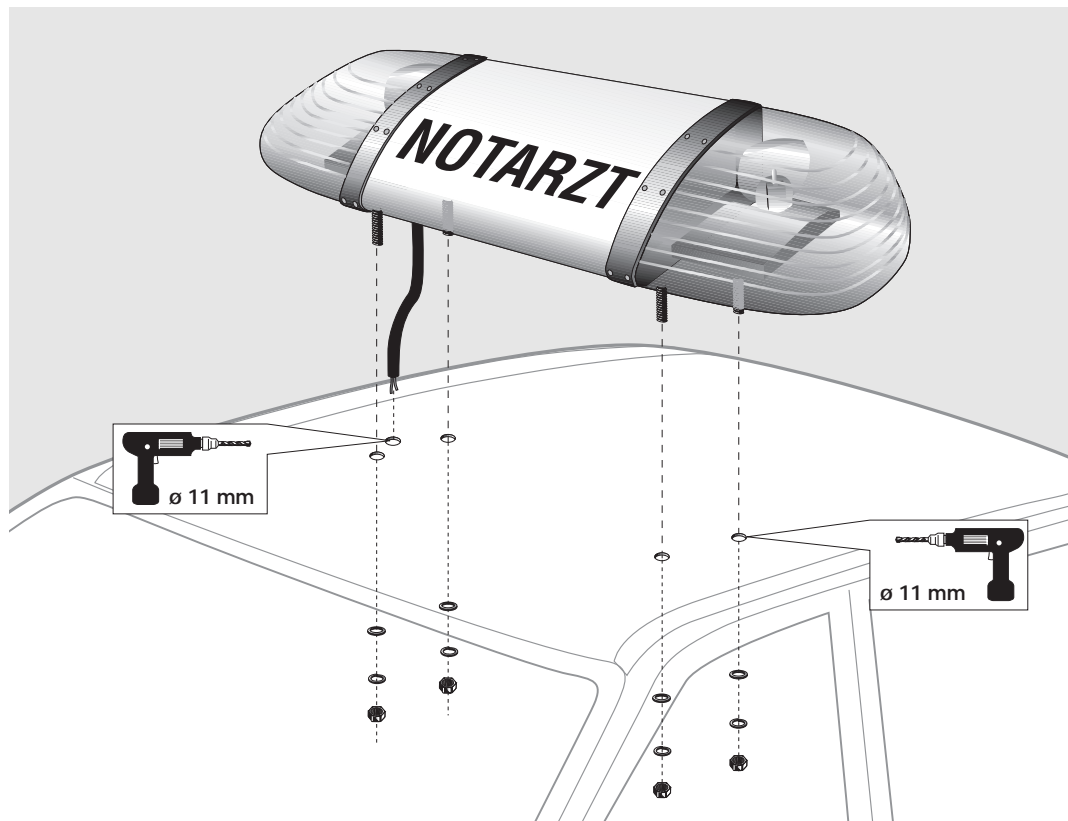

2.1.1 Festmontage mit beiliegenden Gummidichtungen (nicht möglich bei OWS 540)

Befestigungsschrauben M 10 in die Befestigungsstege der Träger rechts und links einsetzen.

Gummidichtung in Montagefuß eindrücken.

Anschlußkabel durch die Kabelöffnung führen, die Befestigungsschrauben in die vorgebohrten Löcher im Fahrzeugdach stecken, das Gerät aufsetzen und fest verschrauben.

Nach dem Befestigen kontrollieren, ob die Rundumkennleuchten senkrecht stehen.

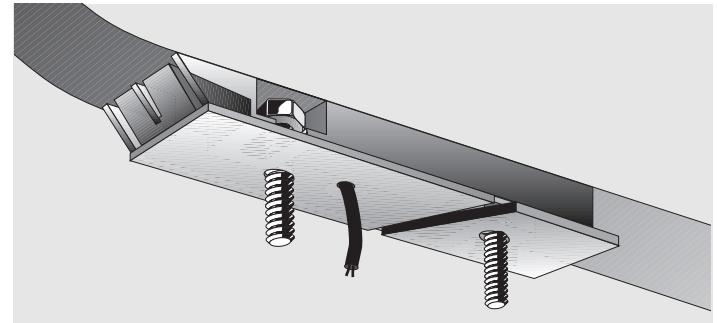
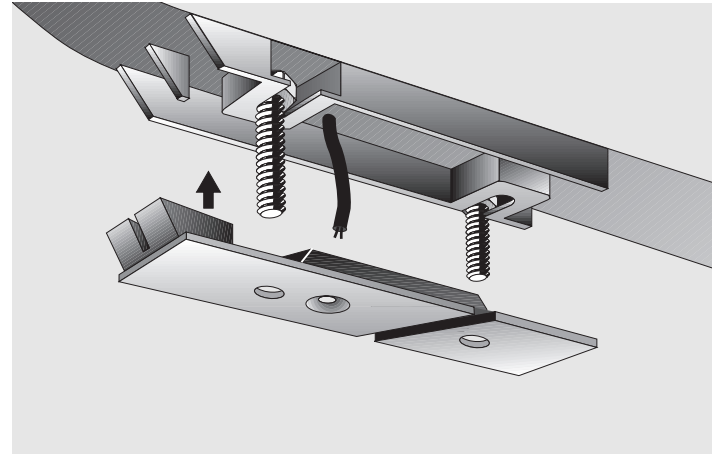

2.1.2 Festmontage mit großer Gummiunterlage

Die beiliegenden Dichtungen werden nicht benötigt.

Befestigungsschrauben M 10 in die Befestigungsstege der Träger rechts und links einsetzen.

Gummiunterlage an der unteren Seite der OWS anbringen.

Das Gerät auf das Fahrzeugdach setzen. Dabei das Kabel durch die Kabelöffnung und die Schrauben in die vorgebohrten Löcher führen.

Die OWS anschließend fest verschrauben.

Nach dem Befestigen kontrollieren, ob die Rundumkennleuchten senkrecht stehen. Eine Niveauekorrektur ist durch unterschiedliches Anziehen der Befestigungsschrauben möglich.

360° Rundumsichtbarkeit beachten!



2.2 Spannmontage

(siehe Zubehör Pkt. 6.0)

Als Alternative zur Festmontage ist eine Spannmontage möglich. Dafür wird nur das Kabelloch gebohrt. Die beiliegenden Gummidichtungen in den Montagefuß der OWS eindrücken.

Befestigungssystem
9DX 857 445-001 unter den
Halter schrauben.

Dieses System nun unter die
OWS mit Gummidichtung
schrauben.

Die Spannbügel müssen
dem jeweiligen Fahrzeugtyp
angepaßt werden.

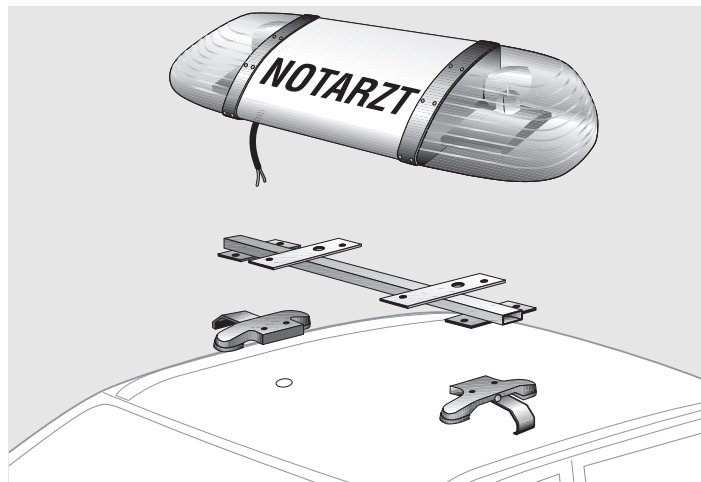

2.3 Magnetmontage

Die OWS 540 mit Magnetfuß ermöglicht ein schnelles Wechseln der gesamten Kennleuchteinheit.

Die Kennleuchteinheit darf nur auf Stahldächer gesetzt werden!

Die Aufsatzfläche muß frei von Schmutz, Wasser, Eis, Schnee, Blättern usw. sein.

Achtung! Max. zulässige
Höchstgeschwindigkeit
120 km/h!

Der elektrische Anschluß
(Leitungsführung), zur DIN-
Autosteckdose, kann durch
das geöffnete Fenster vorge-
nommen werden. Dabei ist
darauf zu achten, daß die
Anschlußleitung weder
gequetscht noch geknickt
wird.

Die Kennleuchteinheit bei
Nichtgebrauch im Fahrzeug so
aufbewahren, daß während
der Fahrt keine Behinderung
für Fahrer und Beifahrer
auftritt!

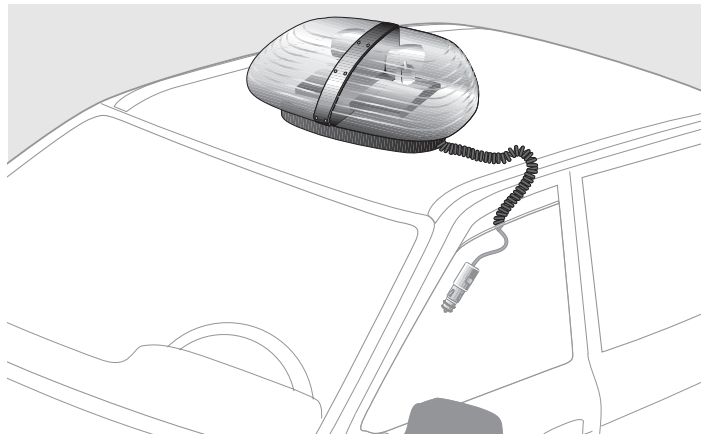

3.0 Elektrischer Anschluß

Die Fahrzeugbatterie ist vor Montagebeginn abzuklemmen. Der Kabelsatz ist am besten über die Seitenholme des Fahrzeuges nach vorn zu führen. Dabei ist zu beachten, daß eine starke Knickung an Ecken und Kanten vermieden wird.

Kennleuchten:
 12 V = 2 x 55 W;
 24 V = 2x70 W
 Leitung im Fahrzeug verlegen, auf Länge abschneiden und über Schalter anschließen.

- Plusleitung = weiß
(absichern, Schalter mit Kontrolleuchte (s. Ersatzteile))
- Minusleitung = blau
- Nachrüstung z.B.
Innenbeleuchtung: schwarz,
braun

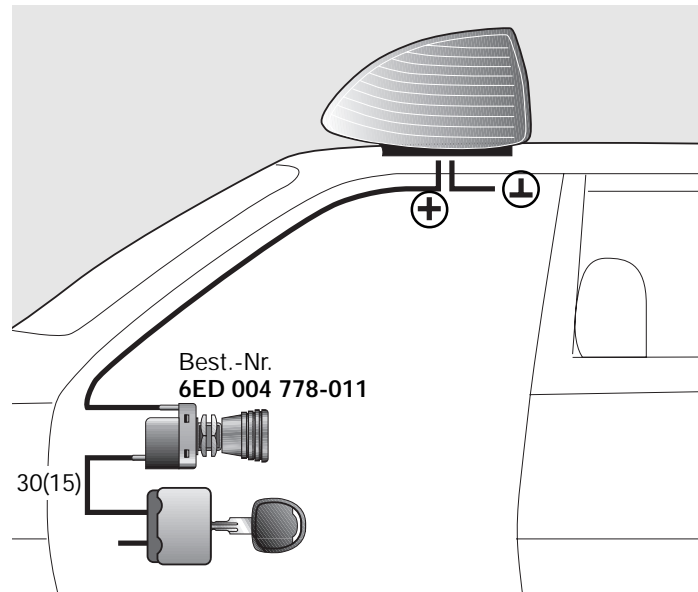

4.0 Technische Daten

Technische Daten zum Hella OWS

Allgemeine Technische Daten	
Breite	~ 300 mm
Höhe (ohne Unterlage)	~ 180 mm
Gewicht:	
OWS 540	~ 3,0 kg
OWS 1000	~ 5,5 kg
OWS 1400	~ 7,0 kg
OWS 1600	~ 8,0 kg
Schutzart: IP 5K4K9K (Hochdruckreiniger)	
Betriebstemperatur:	- 40 °C bis + 60 °C
Lagertemperatur:	- 40 °C bis + 85 °C
Betriebsspannung:	(U _N)12 V und 24 V
Betriebsspannungsbereich	
12 V	10...15,5 V
24 V	20...31,0 V
Stromaufnahme	
Rundum-Kennleuchten	2 x 4,7 A (12 V) 2 x 2,7 A (24 V)
Lichtscheibe beleuchtet	~4 A (12 V) ~2 A (24 V)

Technische Daten für optische Systeme	
Antrieb: Schneckenantrieb	
Nenn Drehzahl: 160 min ⁻¹	
Silberfarbig lackierter Parabolreflektor mit stehender Glühlampe (gelbe Ausführung)	
Hgl bedampfter Parabolreflektor mit integrierten Glühlampen (blaue Ausführung)	
H1-Glühlampe: Halogen 12 V / 55 W; 24 V / 70 W	
Lichtscheibe (Material) PMMA milchigweiß	
Lichthaube (Material)	gelb = PC blau = PMMA
Funkentstörung nach VDE 879 Teil 3	
Funkentstörgrad 5, Nahentstörung für Kfz.	
Typprüfung:	blau B1 E1 00817
	gelb A1 E1 00774
	CE e1 021309

5.0 Geräteabarten / Ersatzteile

Komplettsystem

OWS-Typ	Ausführung	Bestell-Nr.
OWS-540	12 V, 2KL, gelb	2RL 007 900-501
OWS-540	12 V, 2KL, blau	2RL 007 900-551
OWS-540	24 V, 2KL, gelb	2RL 007 900-511
OWS-540	24 V, 2KL, blau	2RL 007 900-561
OWS-540 Magnet	12 V, 2KL, gelb	2RL 007 900-521
OWS-540 Magnet	12 V, 2KL, blau	2RL 007 900-571
OWS-1000	12 V, 2KL, gelb	2RL 007 900-001
OWS-1000	12 V, 2KL, blau	2RL 007 900-151
OWS-1400	12 V, 2KL, gelb	2RL 007 900-201
OWS-1400	24 V, 2KL, gelb	2RL 007 900-211
OWS-1400	12 V, 2KL, blau	2RL 007 900-251
OWS-1600	12 V, 2KL, gelb	2RL 007 900-601
OWS-1600	24 V, 2KL, gelb	2RL 007 900-611
OWS-1600	12 V, 2KL, blau	2RL 007 900-651

Ersatzteile

Lichthaube gelb links		9EL 861 912-001
Lichthaube gelb rechts		9EL 861 913-001
Lichthaube blau links		9EL 861 912-021
Lichthaube blau rechts		9EL 861 913-021
Motor		9MN 860 677-021
Reflektor (gelb)		9DX 861 872-001
Reflektor (blau)		9DX 861 976-001
Halogen-Glühlampe		
12 V-55 W		8HG 002 089-131
24 V-70 W		8HG 002 089-251

6.0 Zubehör

Gummiunterlage

Die Gummiunterlagen sind den vier OWS-Modellen angepaßt und aus umweltfreundlichen, witterungsbeständigem Material hergestellt.

Die Unterlage bewirkt eine scheuerfeste und erschütterungsfreie ganzflächige Auflage der OWS auf dem Fahrzeugdach und stellt mit dem Fahrzeug eine optisch geschlossene Einheit dar.

OWS 540
Gummiunterlage
serienmäßig

Länge: 320 mm
Best.-Nr.
9GD 862 121-001

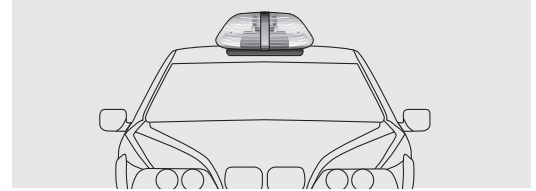

OWS 1000

Länge: 751 mm
Best.-Nr.
9GD 862 080-001

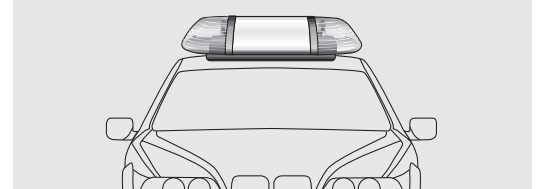
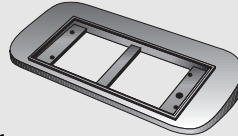

OWS 1400

Länge: 1151 mm
Best.-Nr.
9GD 862 081-001

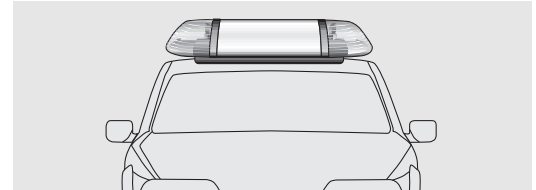
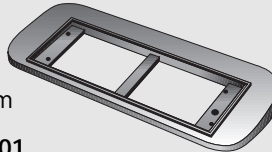

OWS 1600

Länge: 1351 mm
Best.-Nr.
9GD 862 085-001

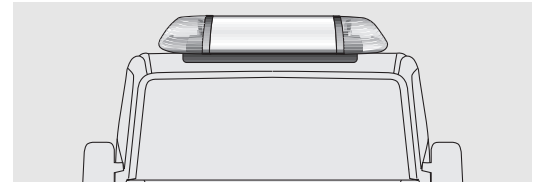
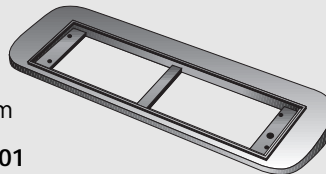

Zubehör

Trägergarnitur

Die Trägergarnitur besteht aus zwei Teilen und wird direkt auf einem bereits bestehenden Halter aufgeschweißt.

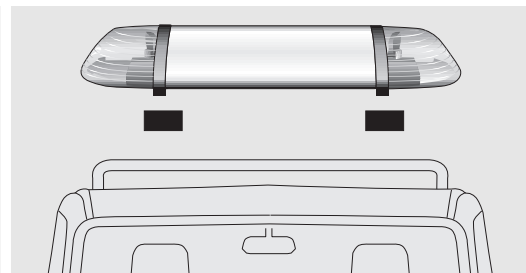
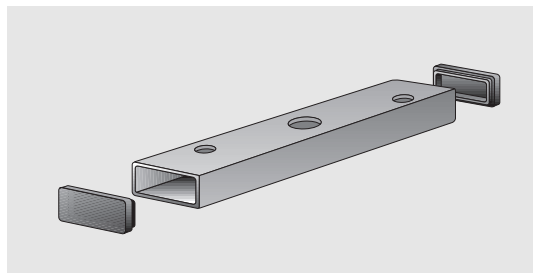

Haltegarntur für Direktmontage

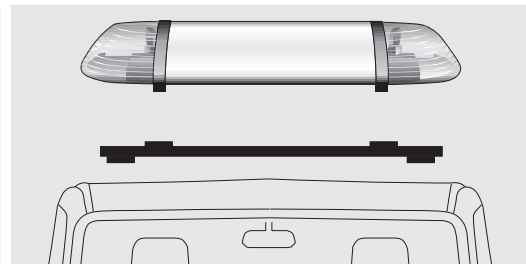
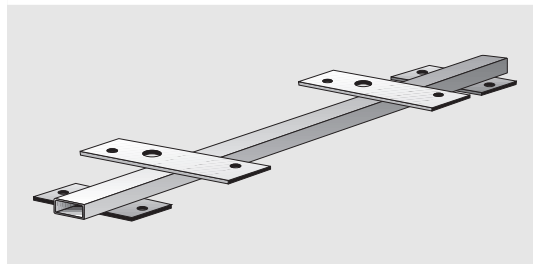

Befestigungssystem 9DX 857 445-001

Spannbügel 9XD 857 421-801

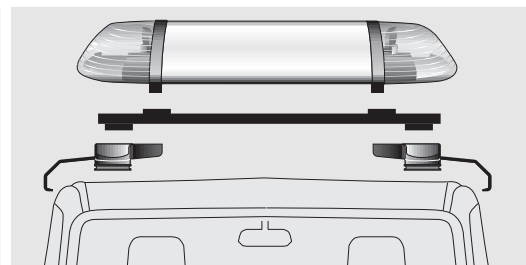
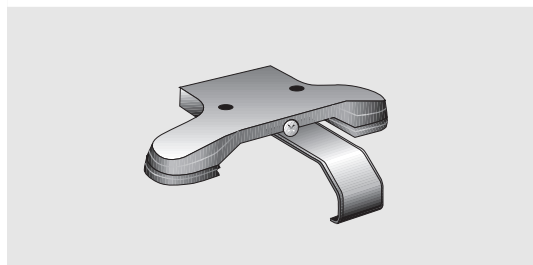

Lampenträger (incl. Leuchtmittel)

Bestückung: OWS 1000 (1 x)
OWS 1400 (2 x)
OWS 1600 (2 x)

Best.-Nr.
9FT 861 790-001 12 V
9FT 861 790-011 24 V

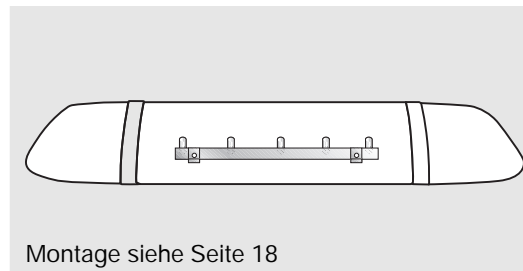
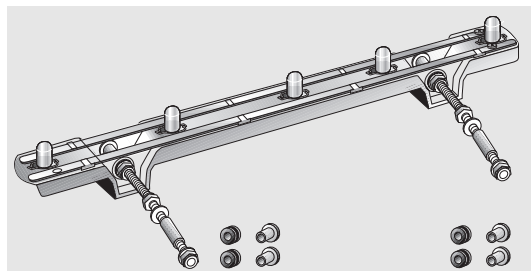

Montage siehe Seite 18

Leuchtmittel (Ersatzteile)

Lichtscheibenbeleuchtung
5 x 5 W bzw. 10 x 5 W
nachrüstbar.

Best.-Nr.
9GP 003 594-131 12 V
9GP 003 594-251 24 V

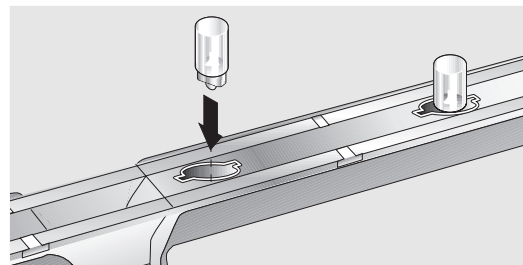
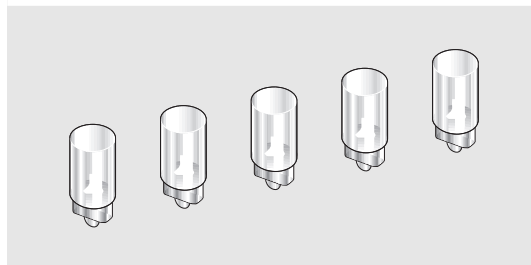

Schalter mit Kontrolleuchte

je 1 Stück
für Innenbeleuchtung

je 1 Stück
für Kennleuchtenbetrieb

Best.-Nr.
6ED 004 778-011

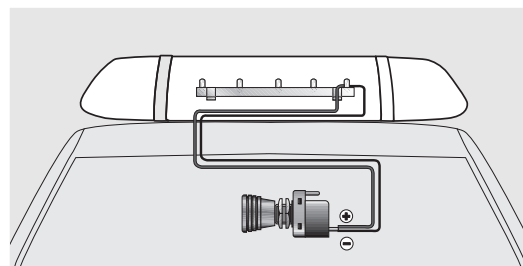
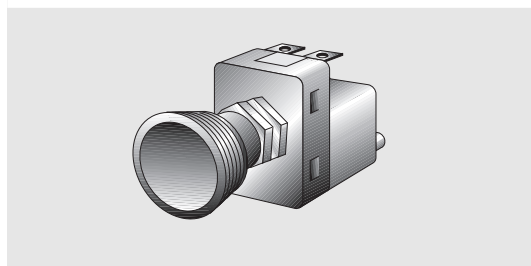

Zubehör

Montage der Lichtscheibenbeleuchtung

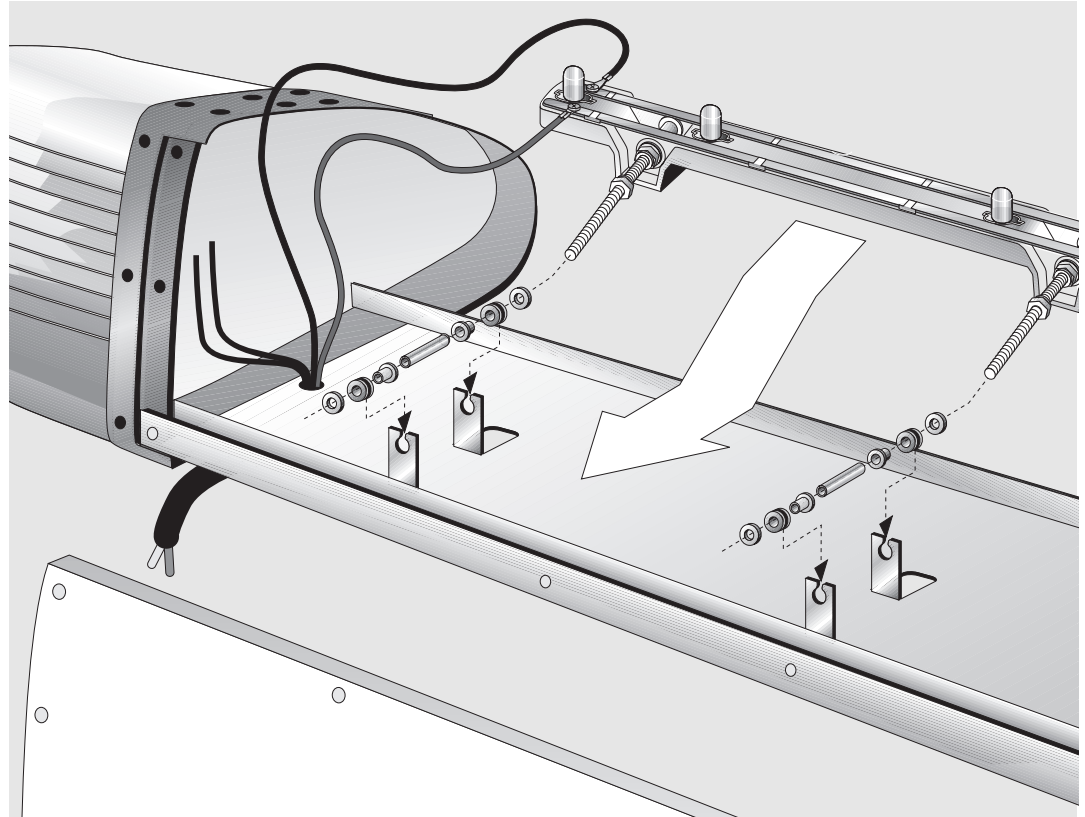

7.0 Fehlersuche

Rundum-Kennlicht

Rundum-Kennlicht	Mögliche Ursache
Eine oder beide KL sind bei sich drehendem Reflektor ohne Licht	Prüfen, ob Glühlampe defekt.
Reflektor dreht sich nicht, Glühlampen aber in Ordnung.	Prüfen, ob Antrieb bzw. Motor defekt.
Beide KL ohne Licht, Reflektoren drehen sich nicht.	Prüfen, ob am Sicherungskasten Eingang bzw. Ausgang Bordspannung ansteht.
	ja = Prüfen, ob im Gerät an den Klemmen 72 (Motor) Bordspannung ansteht.
	nein = Zuleitung 30 zum Sicherungskasten bzw. Sicherung defekt.
	Prüfen, ob Masseleitung zu den Kennleuchten Durchgang hat.

Beleuchtung der Werbefläche

Störung	Mögliche Ursache
Schriftzug nicht vollständig ausgeleuchtet.	Prüfen, ob Glühlampe oder Sicherung defekt.

Wenn Sie noch Fragen oder Einbauprobleme haben, gibt Ihnen der Hella Kundendienst schnell und gerne Auskunft unter der Telefonnummer

Außerhalb der Geschäftszeit nimmt ein Anrufbeantworter Ihre Fragen und Wünsche entgegen. Der Hella Kundendienst ruft Sie dann umgehend zurück.

Ⓓ **(0180) 5 25 00 02**
(DM 0,24/Min.)

Ⓐ **01/ 6 14 60-0**

Ⓒⓗ **(01) 8 72 75 75**

Hella KG Hueck & Co.
Rixbecker Straße 75

59552 Lippstadt

Hella OWS Visual Warning System

Technical Manual

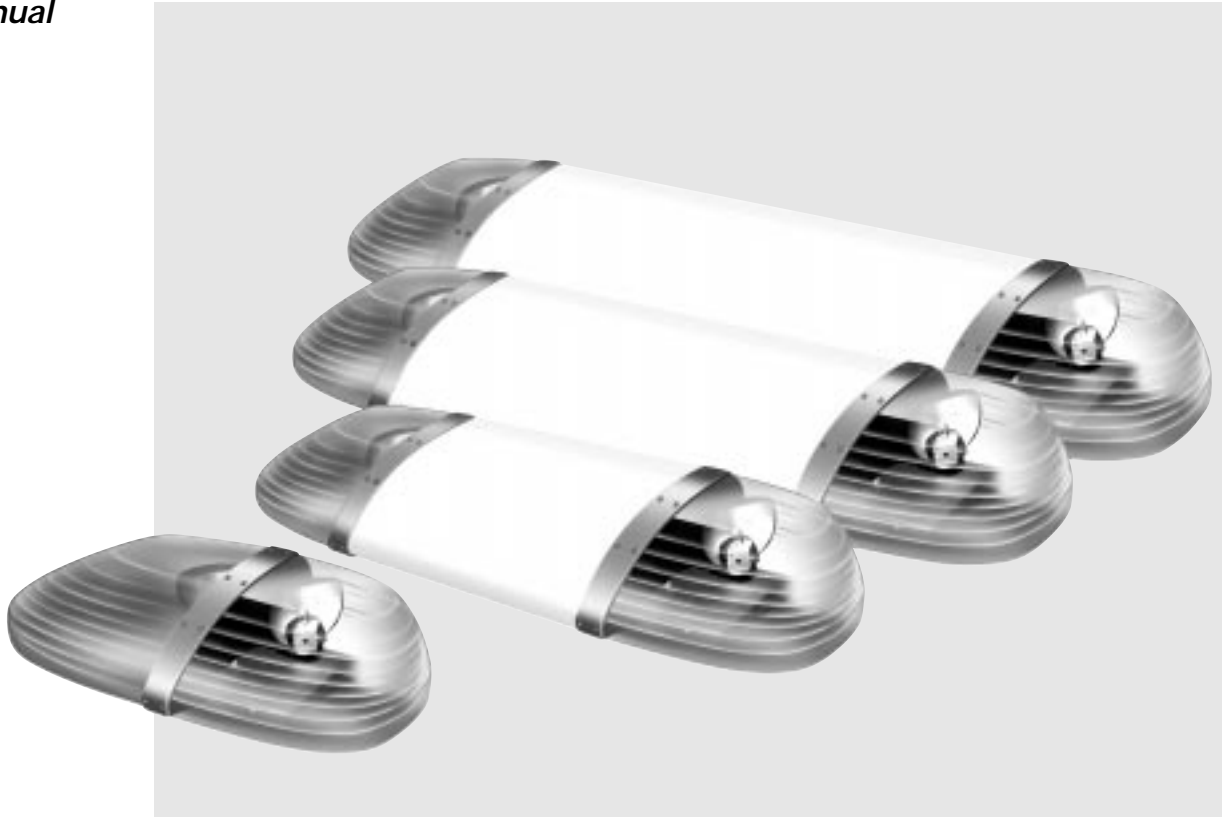

Before mounting please read these mounting and operating instructions all the way through and follow the order of installation precisely. Improper mounting may compromise the operating safety of the vehicle.

Technical Manual

Hella OWS Visual Warning System

Table of Contents

	Page
1.0 General Information	24
2.0 Mounting	26
3.0 Electric Installation	32
4.0 Technical Data	33
5.0 Variants / Replacement Parts	34
6.0 Accessories	35
7.0 Trouble Shooting	39

1.0 General Information

System and functions

The Hella OWS is a compact system with yellow rotating warning beacons and an illuminated advertising field for

individual labels for public road service vehicles, breakdown services, wide and long vehicles.

The system components of the Hella OWS are:

- Yellow beacons (two 360° warning beacons with rotating reflector and H1 halogen bulbs)
- Advertising field for labelling as retrofit kit, illuminated (five or ten bulbs switched parallel)*

*) The illuminated lettering is not permissible in areas covered by the StVZO and in Austria and Switzerland.

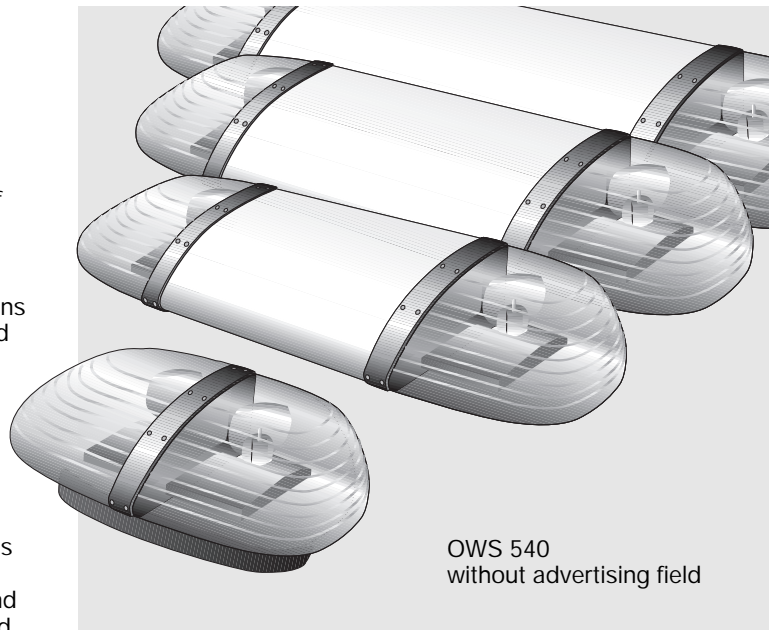

OWS 540
without advertising field

Versatile

The OWS lettering is as versatile as the OWS itself.

The large illuminated panels allow many different types of labelling.

If you clearly mark your vehicle you can expect more attention.

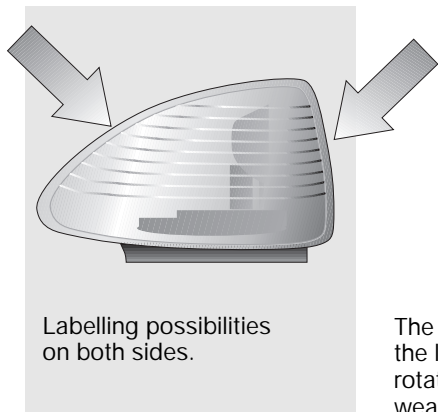
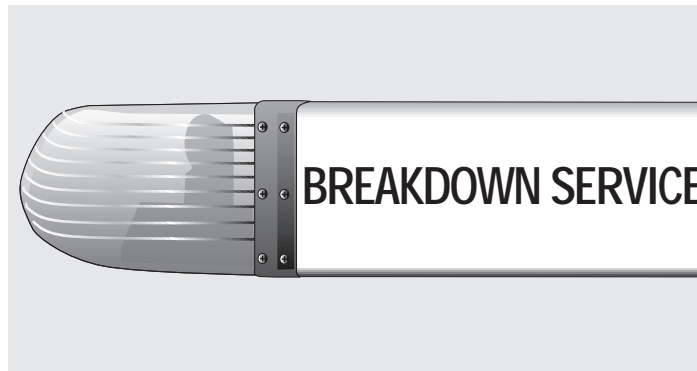

Labelling possibilities on both sides.

The marking will be visible in the light cones of the two rotating beacons even in bad weather.

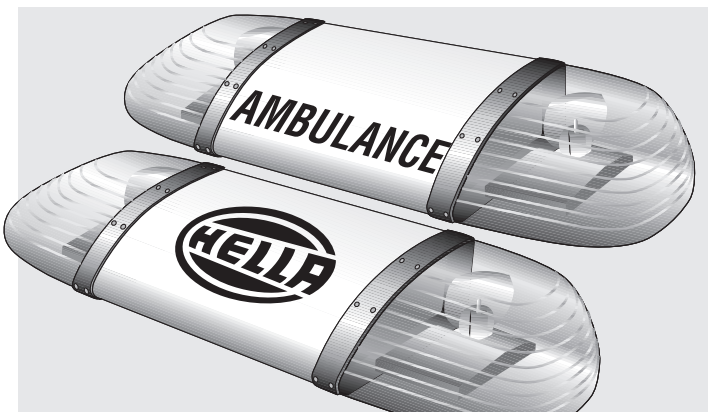

2.0 Mounting

Before mounting, ask the manufacturer if you need to reinforce the roof.

Select a flat location on the roof of the vehicle and prepare for installation depending on the attachment method to be used.

Caution:
After mounting and before every departure make sure the device is properly positioned and the clamping connections are tight.

2.1 Permanent Mounting

Mark the contours of the aligned OWS on the vehicle roof with the aid of the dimensioned drawing. Take account of the curvature of the roof.

Open the roof lining in the passenger compartment. Bore the holes according to the dimensioned drawing. Guide the prepared connecting line through the cable opening.

Take care not to damage subjacent parts of the vehicle by boring. We recommend sealing holes bored through metal with rust protection agents. After mounting, seal cable openings with sealing cement.

The contact area on the roof of the vehicle must be free from snow, ice, and dirt.

Drilling template
OWS 540

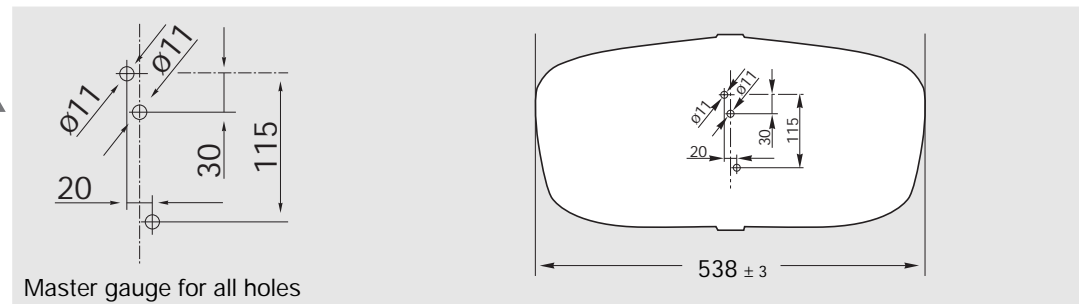

Drilling template
OWS 1000

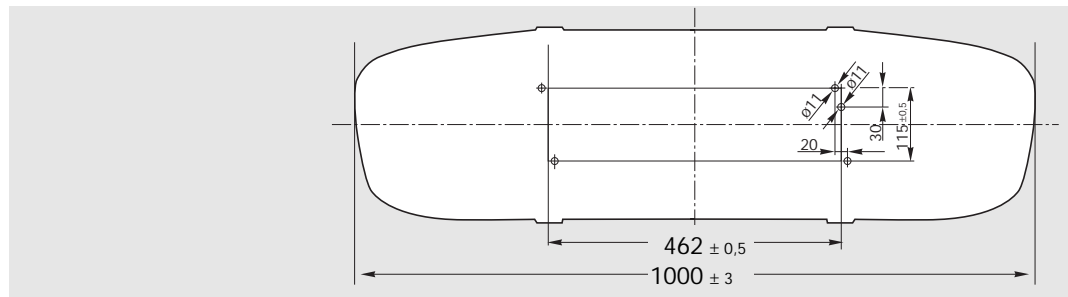

Drilling template
OWS 1400

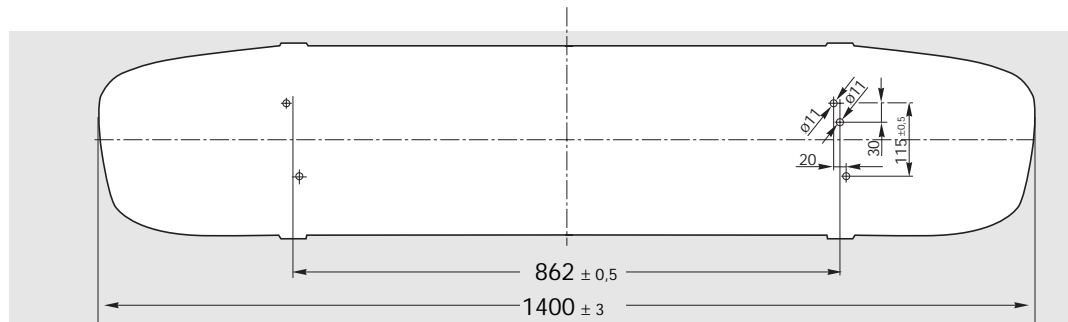

Drilling template
OWS 1600

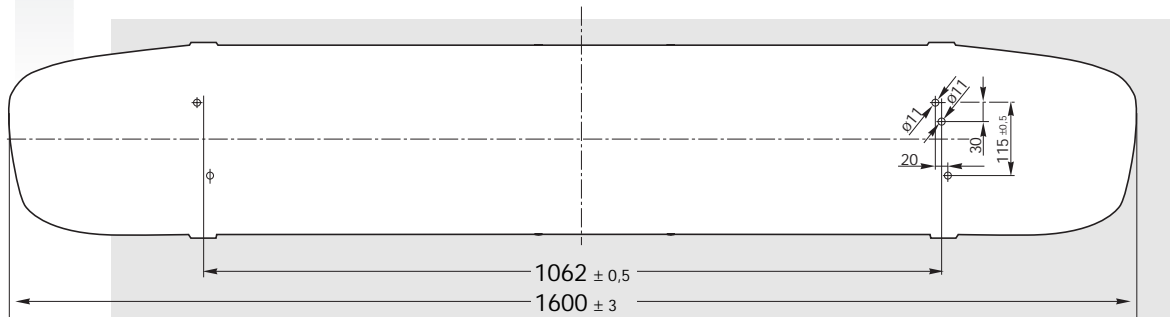

Mounting

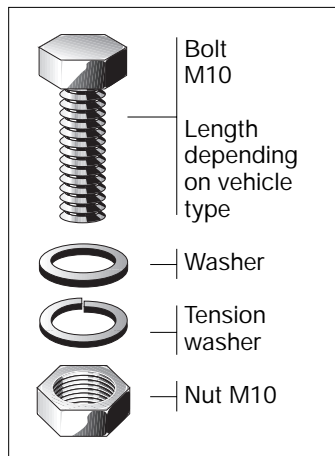

Fixing material not in scope
of delivery

Fastening bolts
M10

Max. tightening moment
4 Nm

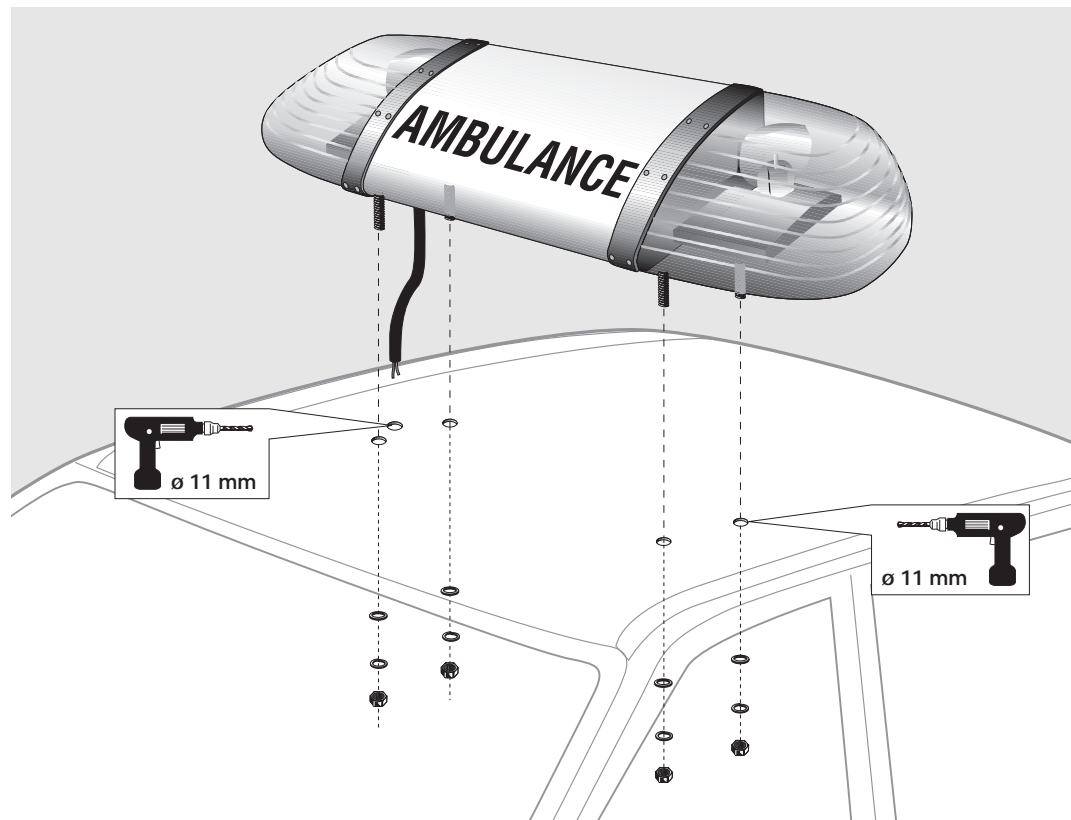

2.1.1 Permanent Mounting with Enclosed Rubber Seals

(not possible with OWS 540)

Insert the M10 bolts into the left and right anchoring bridges of the bracket.

Press the rubber seal into the mounting plate.

Guide the connecting cable through the cable opening, put the fastening bolts through the drilled holes in the vehicle roof, position on the device and tighten the bolts.

After mounting, make sure the beacons are in vertical position.

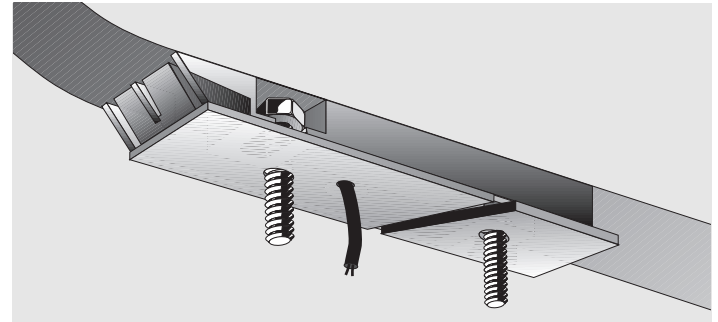
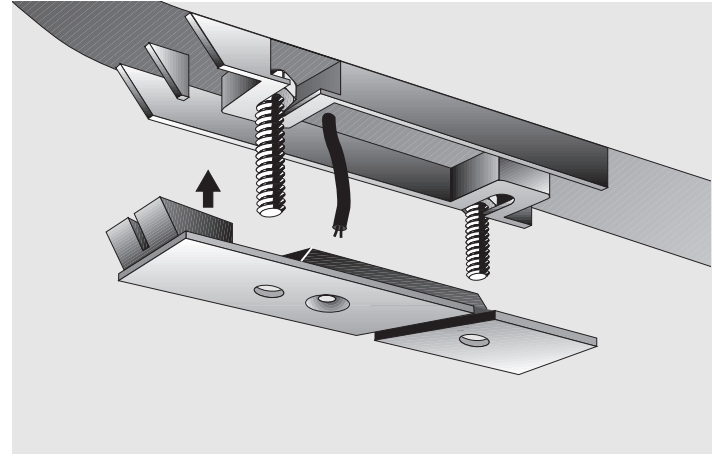

2.1.2 Permanent Mounting with Large Rubber Pad

The enclosed seals are not required.

Insert the M10 bolts into the left and right anchoring bridges of the bracket.

Install the rubber pad on the bottom of the OWS.

Position the device on the vehicle roof and at the same time guide the cable through the cable opening and the bolts into the drilled holes.

After that screw OWS down tight.

After mounting, make sure the beacons are in vertical position. Differences of level can be compensated by loosening or tightening individual bolts.

Make sure beacons are visible in all directions (360°).



2.2 **Clamped Mounting**

(see item 6.0, Accessories)

As an alternative to permanent mounting, the device can be fixed by clamping. Only the cable opening is drilled for this fastening method. Press the enclosed rubber seals into the mounting plate of the OWS.

Screw the 9DX 857 445-001 fastening system under the holder.

Now screw this system under the OWS with rubber seal.

The clamps must be adjusted to the particular vehicle type.

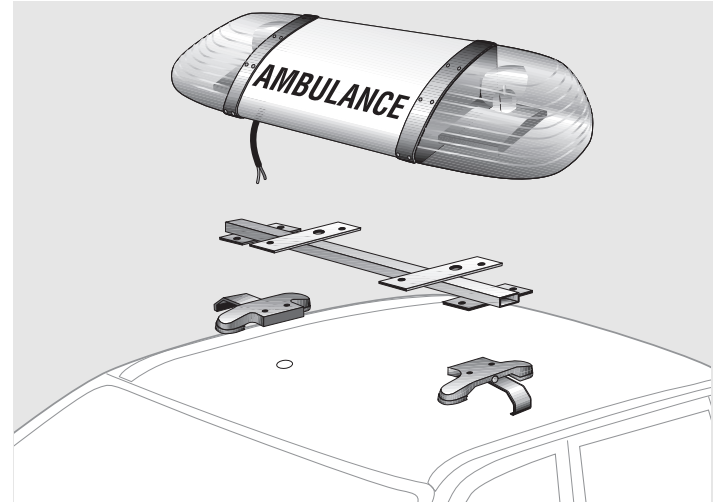

2.3 **Magnetic mounting**

The OWS 540 with magnetic base allows the whole beacon unit to be changed over quickly.

The beacon unit may only be placed on steel roofs! The attachment surface must be free of dirt, water, ice, snow, leaves etc.

Attention: Max. permissible speed is 120 km/h.

The electrical connection (arrangement of the wiring) to the DIN car socket can be through the open window. Care must be taken that the connecting wire is neither pinched nor kinked.

When not in use, the beacon unit must be stored in the vehicle in such a way that it does not impede the driver and front seat passenger in any way during driving.

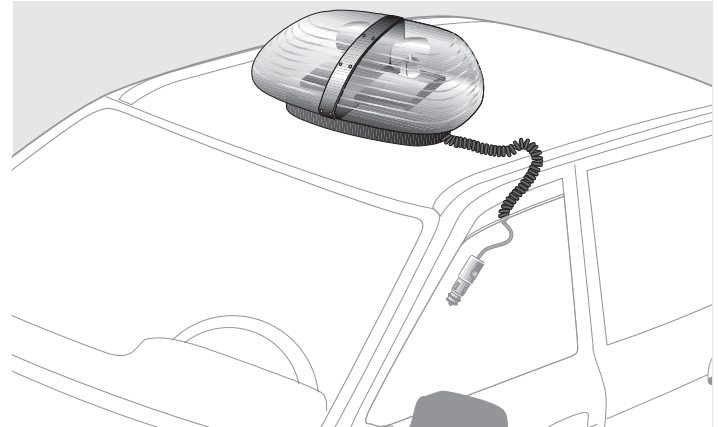

3.0 Electrical Installation

Before mounting disconnect the vehicle battery. It is advisable to guide the cable harness to the front through the side cross-ties. Avoid kinking of the cables in corners and edges.

Beacons:
 12 V = 2 x 55 W;
 24 V = 2 x 70 W
 Install the cable in the vehicle, cut to length, and connect via switch.

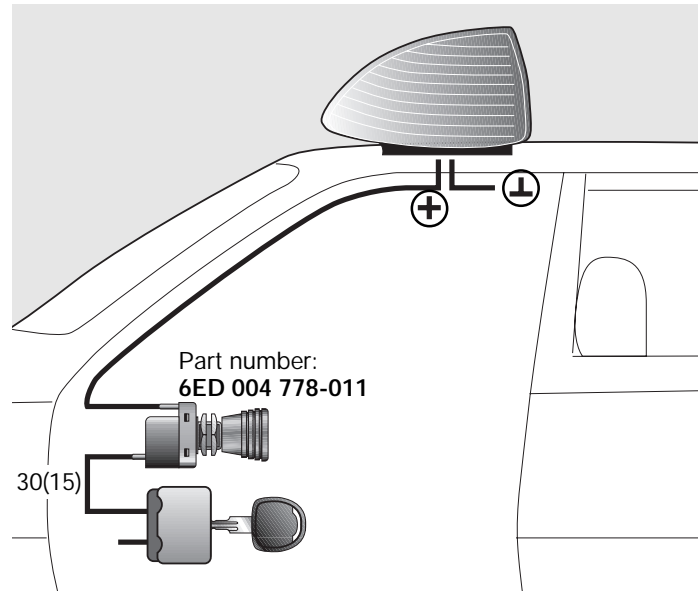

- Positive line = white (protect by fuse, switch with indicator lamp (see replacement parts))
- Negative line = blue
- Retrofitting, e.g. illumination: black, brown



4.0 Technical Data

Technical data of Hella OWS

General technical data	
Width:	~ 300 mm
Height (without pad):	~ 180 mm
Weight:	
OWS 540	~ 3.0 kg
OWS 1000	~ 5.5 kg
OWS 1400	~ 7.0 kg
OWS 1600	~ 8.0 kg
Protection type:	IP 5K4K9K (high-pressure cleaner)
Operating temperature:	- 40 °C to + 60 °C
Storage temperature:	- 40 °C to + 85 °C
Operating voltage:	(U _N)12 V and 24 V
Operating voltage range:	
12 V	10...15.5 V
24 V	20...31.0 V
Current consumption:	
Rotating beacons	2 x 4,7 A (12 V) 2 x 2,7 A (24 V)
Illuminated panel	~4 A (12 V) ~2 A (24 V)

Technical data of optical systems			
Drive: worm gear			
Nominal speed: 160 min ⁻¹			
Silver painted parabolic reflector with stationary bulb (yellow version)			
High-gloss vapourised parabolic reflector with integrated bulbs (blue version)			
H1-bulb: Halogen 12 V / 55 W; 24 V / 70 W			
Illuminated panel (material)	PMMA milky white		
Illuminated dorne (material)	yellow = PC blue = PMMA		
Radio interference suppression acc. to VDE 879 part 3			
Radio interference level 5,			
Short-distance interference shielding for motor vehicles			
Type test:	blue	B1	 00817
	yellow	A1	 00774
	CE		 021309

5.0 Variants / Replacement Parts

Complete system

OWS type	Design	Part no.
OWS-540	12 V, 2KL, yellow	2RL 007 900-501
OWS-540	12 V, 2KL, blue	2RL 007 900-551
OWS-540	24 V, 2KL, yellow	2RL 007 900-511
OWS-540	24 V, 2KL, blue	2RL 007 900-561
OWS-540 Magnet	12 V, 2KL, yellow	2RL 007 900-521
OWS-540 Magnet	12 V, 2KL, blue	2RL 007 900-571
OWS-1000	12 V, 2KL, yellow	2RL 007 900-001
OWS-1000	12 V, 2KL, blue	2RL 007 900-151
OWS-1400	12 V, 2KL, yellow	2RL 007 900-201
OWS-1400	24 V, 2KL, yellow	2RL 007 900-211
OWS-1400	12 V, 2KL, blue	2RL 007 900-251
OWS-1600	12 V, 2KL, yellow	2RL 007 900-601
OWS-1600	24 V, 2KL, yellow	2RL 007 900-611
OWS-1600	12 V, 2KL, blue	2RL 007 900-651

Replacement parts

Dome yellow left		9EL 861 912-001
Dome yellow right		9EL 861 913-001
Dome blue left		9EL 861 912-021
Dome blue right		9EL 861 913-021
Motor		9MN 860 677-021
Reflector (yellow)		9DX 861 872-001
Reflector (blue)		9DX 861 976-001
Halogen bulb		
12 V-55 W		8HG 002 089-131
24 V-70 W		8HG 002 089-251

6.0 Accessories

Rubber pad

The rubber pads are adapted to the four OWS types and consist of environment-friendly, weather-proof material.

The pad supports the entire bearing area of the OWS on the roof so as to avoid scraping and vibration and forms a harmonious whole with the vehicle.

OWS 540

Rubber pad as standard

Length: 320 mm
Part no.:
9GD 862 121-001

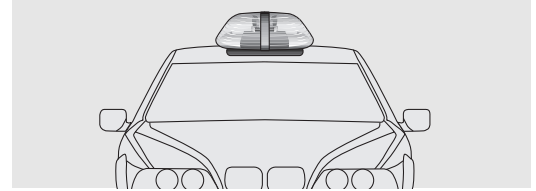

OWS 1000

Length: 751 mm
Part no.:
9GD 862 080-001

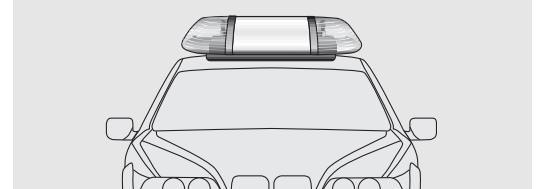
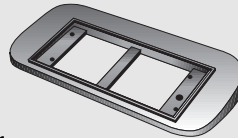

OWS 1400

Length: 1151 mm
Part no.:
9GD 862 081-001

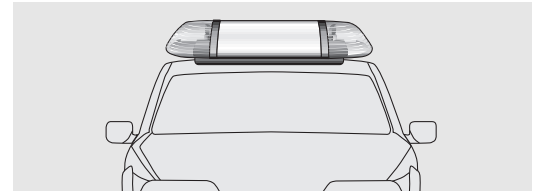
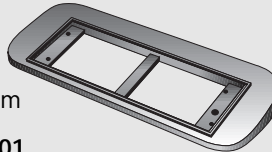

OWS 1600

Length: 1351 mm
Part no.:
9GD 862 085-001

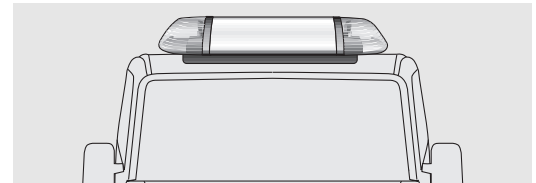
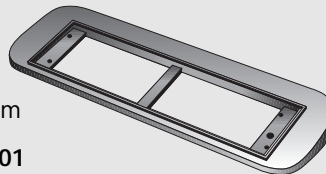

Accessories

Bracket fittings

The bracket fittings consist of two parts and are welded directly to the existing mount.

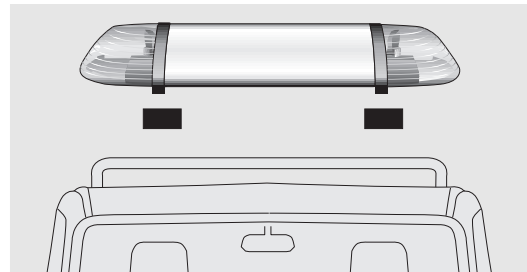
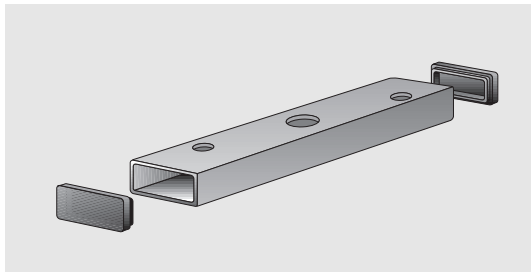

Bracket fittings for direct mounting

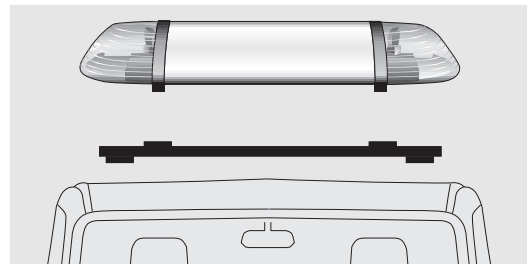
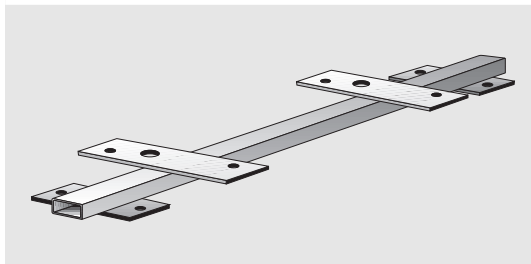

Fastening system 9DX 857 445-001

Clamp 9XD 857 421-801

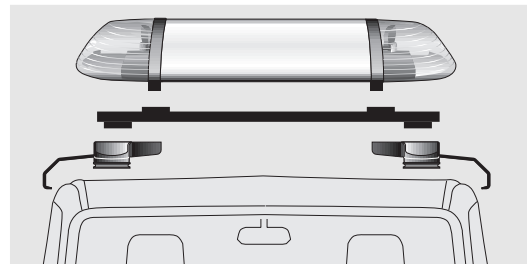
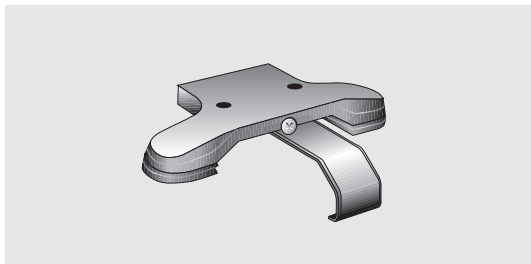

Bulb holder (incl. bulbs)

Equipment: OWS 1000 (1 x)
OWS 1400 (2 x)
OWS 1600 (2 x)

Part no.:
9FT 861 790-001 12 V
9FT 861 790-011 24 V

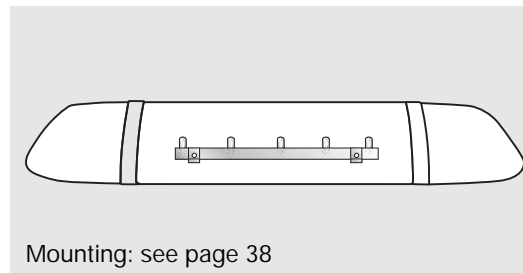
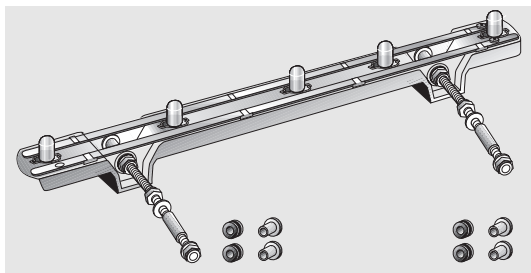

Bulbs (replacement parts)

Panel illumination
5 x 5 W or 10 x 5 W can be
retrofitted.

Part no.:
9GP 003 594-131 12 V
9GP 003 594-251 24 V

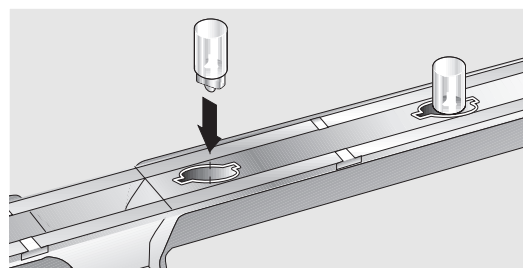
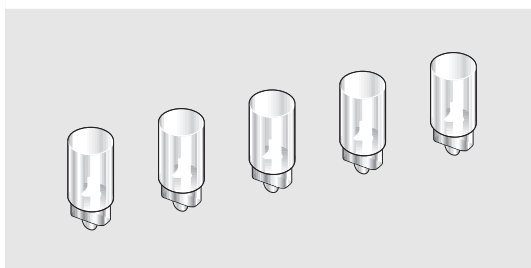

Switch with indicator lamp

1 piece each
for interior lighting
1 piece each
for rotating beacon operation

Part no.:
6ED 004 778-011

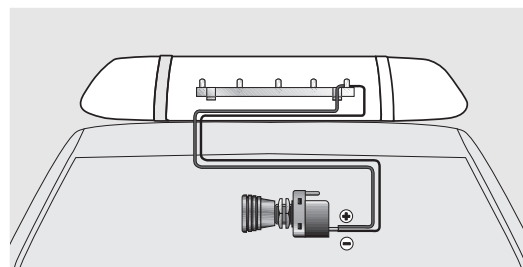
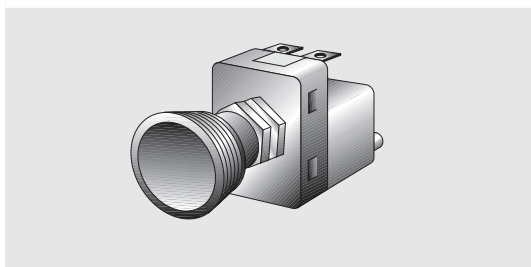

Accessories

Mounting of panel illumination unit.

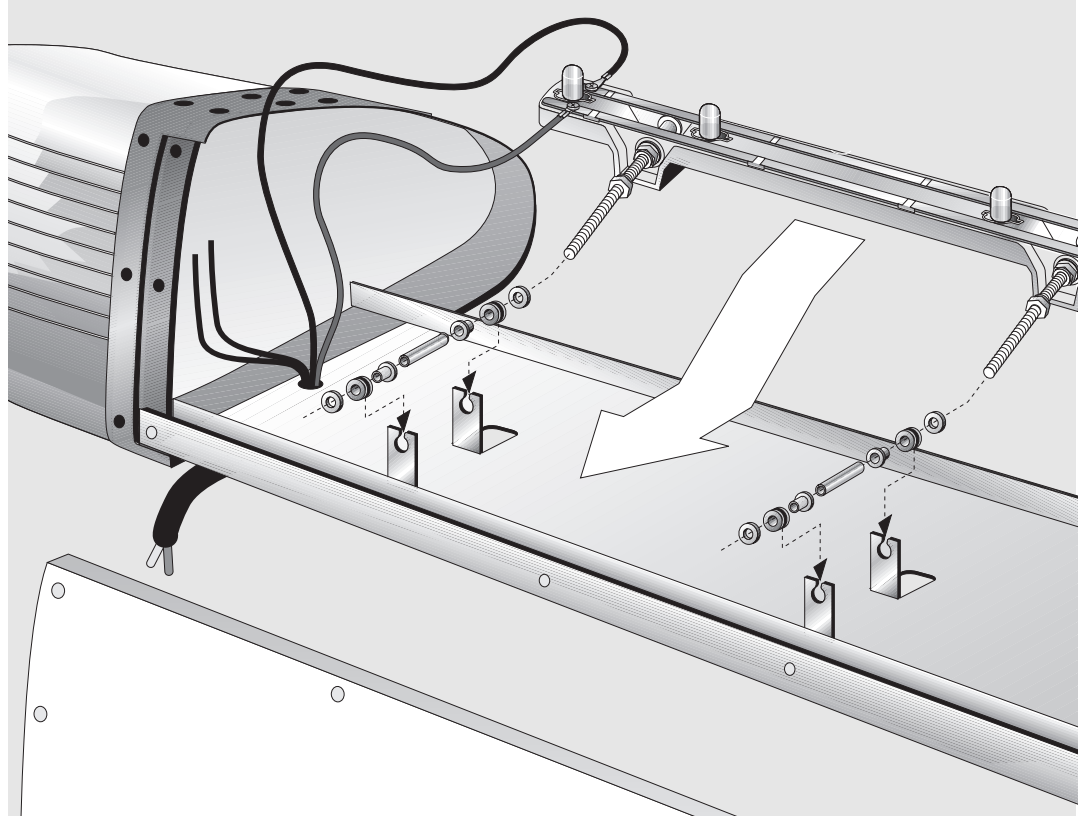

7.0 Trouble Shooting

Rotating beacon

Rotating beacon	Possible cause	
One or both RBs without light while reflector rotates	Check if bulb defective.	
Reflector does not rotate, bulbs are OK.	Check if drive or motor defective.	
Both RBs without light, reflectors do not rotate.	Check on-board voltage at the input/output of fuse box	yes = Check voltage in the device at terminal 72 (motor).
		no = Cable 30 to the fuse box or fuse defective.
	Check continuity of earth connection to the beacons.	

Advertising field illumination

Malfunction	Possible cause
Lettering not completely illuminated.	Check if bulb or fuse defective.

If you have any questions or problems relating to installation, please contact your stockist.

Hella KG Hueck & Co,
P.O. Box 2840,

59592 Lippstadt, Germany

Systeme de signalisation lumineuse OWS Hella

Manuel technique

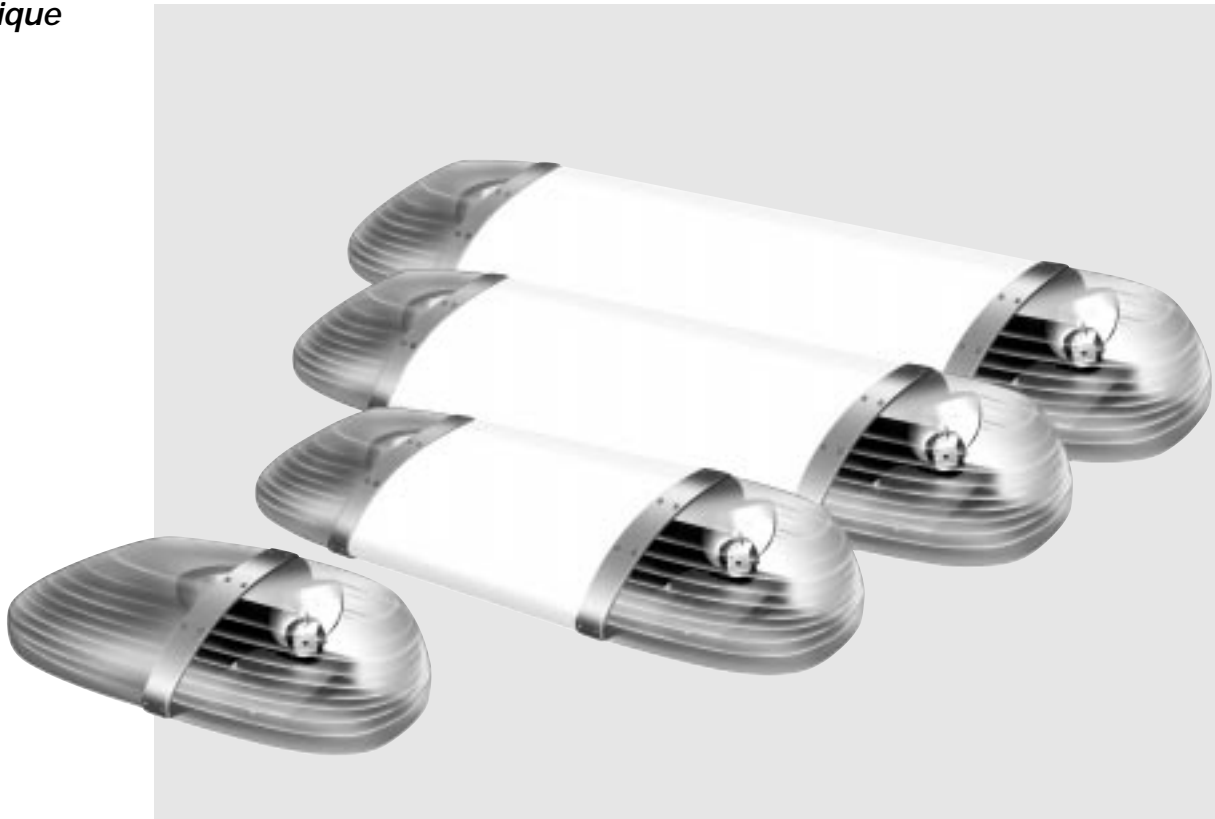

Avant de procéder au montage, veuillez lire attentivement les présentes instructions de montage et de commande et observer scrupuleusement l'ordre des opérations décrites. Un montage non correct peut menacer la sécurité de votre véhicule.

Manuel technique

Systeme de signalisation lumineuse OWS Hella

Sommaire

	Page
1.0 Informations générales	44
2.0 Montage	46
3.0 Branchement électrique	52
4.0 Caractéristiques techniques	53
5.0 Modèles/Pièces de rechange	54
6.0 Accessoires	55
7.0 Détection des défaillances	59

1.0 Informations générales

Système et fonctions

Le système OWS de Hella comprend les composants ci-après :

- Feux de signalisation orange, (deux feux rotatifs sur 360° avec réflecteur rotatif et lampes halogènes H1).
- Caisson central pouvant recevoir des inscriptions avec éclairage par l'intérieur (cinq ou dix lampes couplées en parallèle)*.

*) Les inscriptions éclairées par l'intérieur sont interdites en Allemagne ainsi qu'en Autriche et en Suisse.

Le système de signalisation optique OWS est un système compact destiné aux véhicules de chantier, des services publics et de dépannage, aux véhicules

spéciaux ou hors normes à feux rotatifs orange et à caisson central pouvant recevoir des inscriptions personnalisées et pouvant être illuminé.

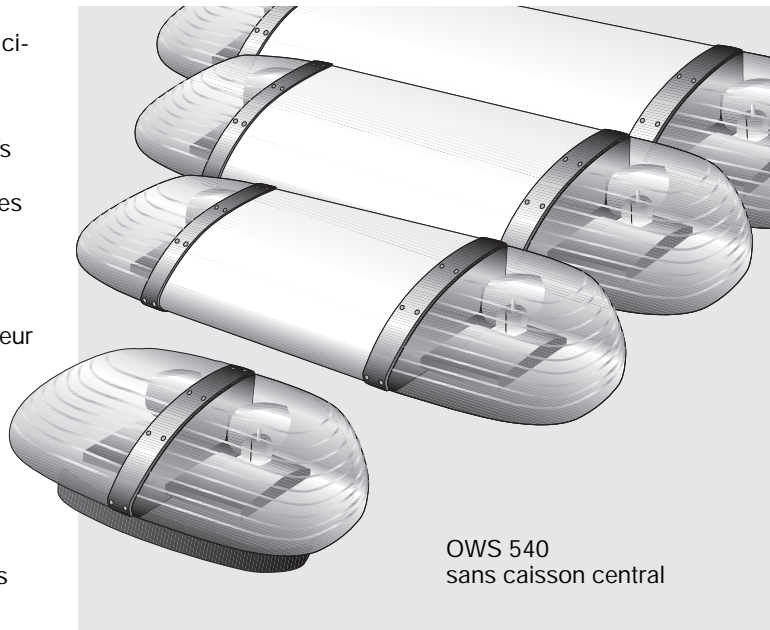

OWS 540
sans caisson central

Utilisation universelle

Les inscriptions possibles sont tout aussi variées que les possibilités d'utilisation du système OWS.

Les caissons se prêtent à une multitude d'inscriptions.

Les faces avant et arrière des caissons peuvent porter les inscriptions de votre choix.

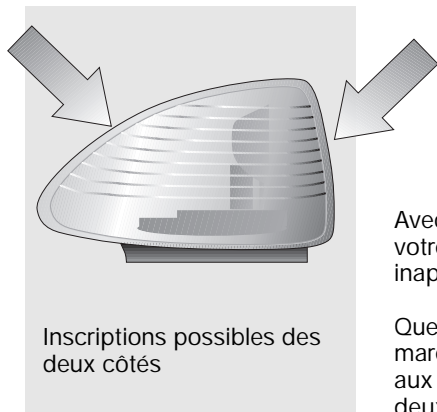
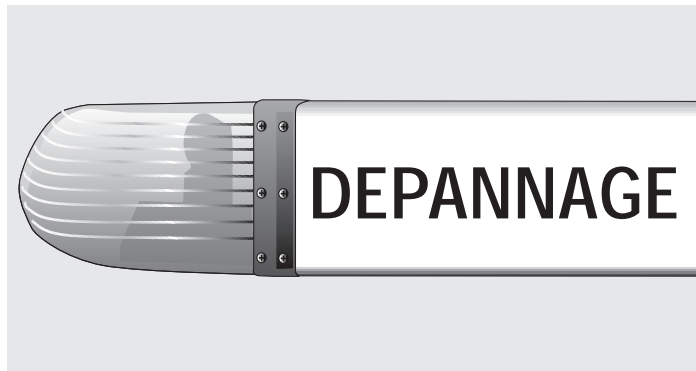

Inscriptions possibles des deux côtés

Avec une signalisation efficace votre véhicule ne passera pas inaperçu.

Quel que soit le temps, le marquage reste visible grâce aux faisceaux lumineux des deux feux rotatifs.

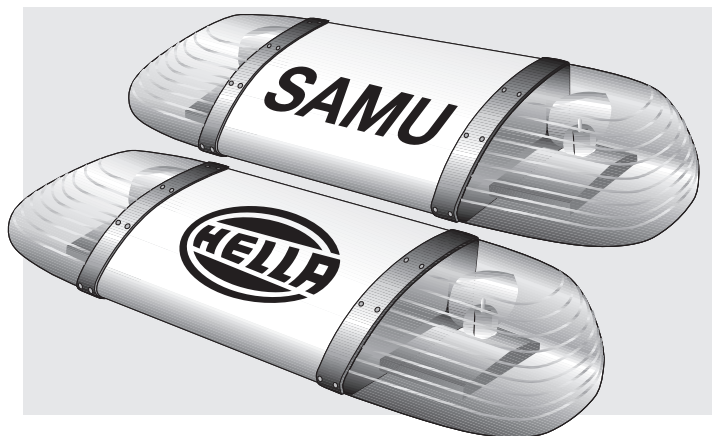

2.0 Montage

Avant de procéder au montage, il est nécessaire de clarifier avec le constructeur si le toit doit ou non être renforcé.

Choisir un endroit plat sur le toit du véhicule et préparer la fixation du système selon le type de montage envisagé.

Attention:

Le bon maintien de l'installation et des assemblages doit être contrôlé après chaque montage et avant toute utilisation du véhicule.

2.1 Montage fixe

Servez-vous du croquis coté pour dessiner les contours du système OWS à mettre en place sur le toit du véhicule. Tenez compte du galbe du toit.

Ouvrez les garnitures du pavillon à l'intérieur du véhicule. Percez les trous selon le croquis coté. Faites passer le fil de connexion par l'ouverture pratiquée.

Lors du perçage, veillez à ne pas endommager les éléments sous-jacents du véhicule. Nous recommandons de sceller les trous percés dans la carrosserie avec un produit anti-rouille. Après le montage, bouchez le passage du câble avec une colle d'étanchéité.

La surface d'appui sur le toit ne doit pas être encombrée de neige, de verglas et de salissures.

Gabarit de perçage
OWS 540

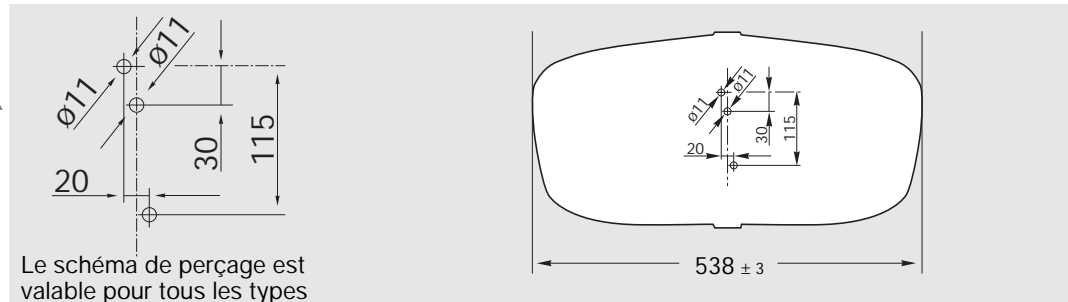

Gabarit de perçage
OWS 1000

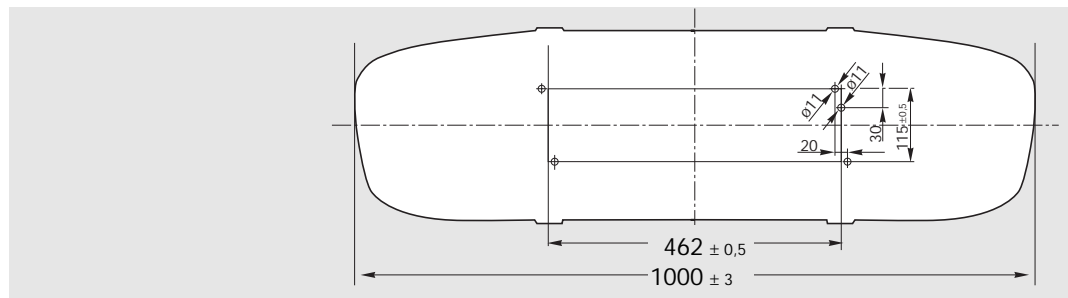

Gabarit de perçage
OWS 1400

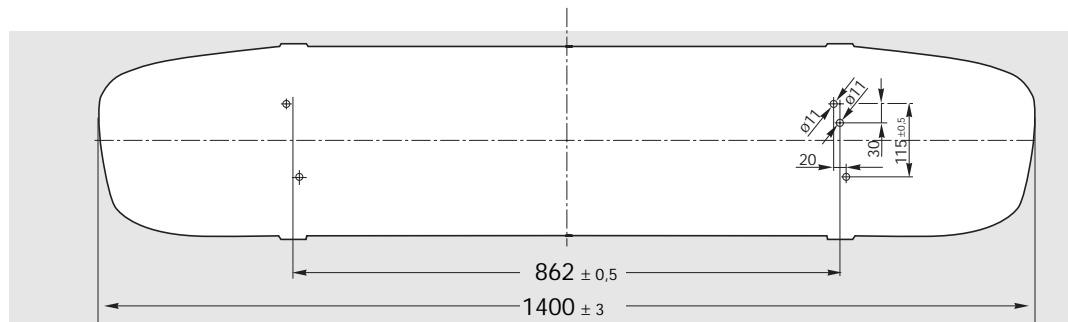

Gabarit de perçage
OWS 1600

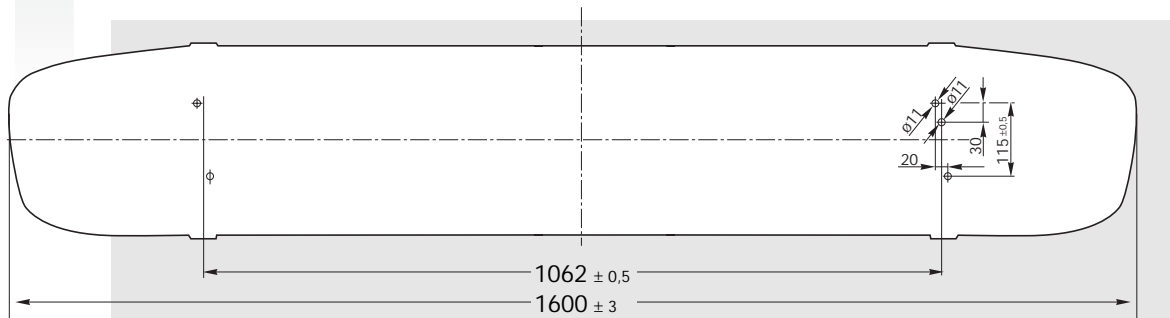

Montage

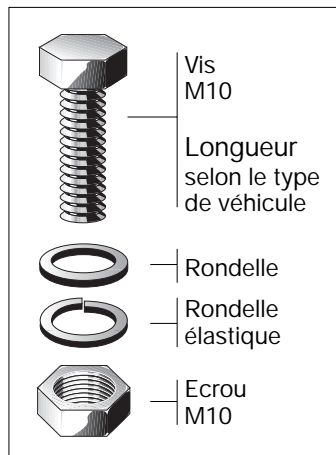

Le matériel de fixation n'est pas fourni.

Vis de fixation
M10

Couple de serrage max.
4 Nm

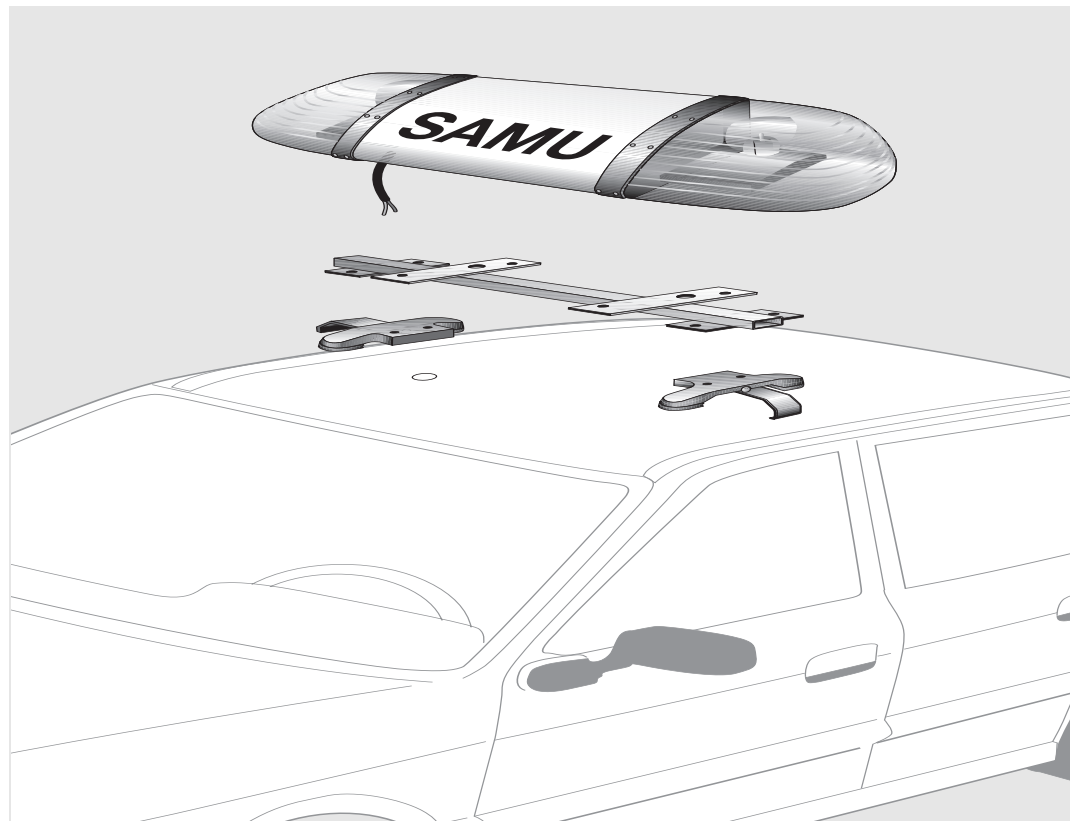

2.1.1 Montage fixe avec joints en caoutchouc fournis (excepté OWS 540)

Mettez en place les vis de fixation M 10 dans les entretoises de fixation des supports à droite et à gauche.

Enfoncez le joint en caoutchouc dans la platine de montage.

Faites passer le fil de connexion par le passe-câble, insérez les vis de fixation dans les trous percés sur le toit du véhicule, mettez en place l'appareil et vissez-le fermement.

Après la fixation, contrôlez si les feux rotatifs sont bien à la verticale.

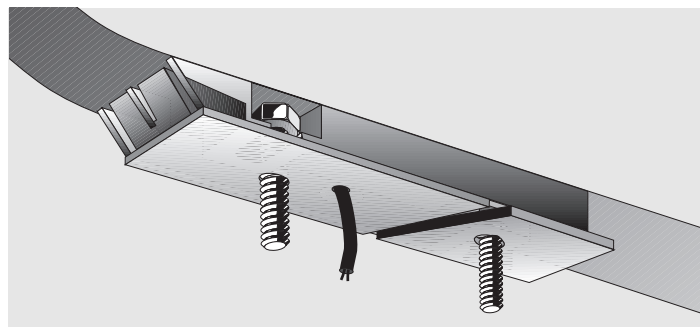
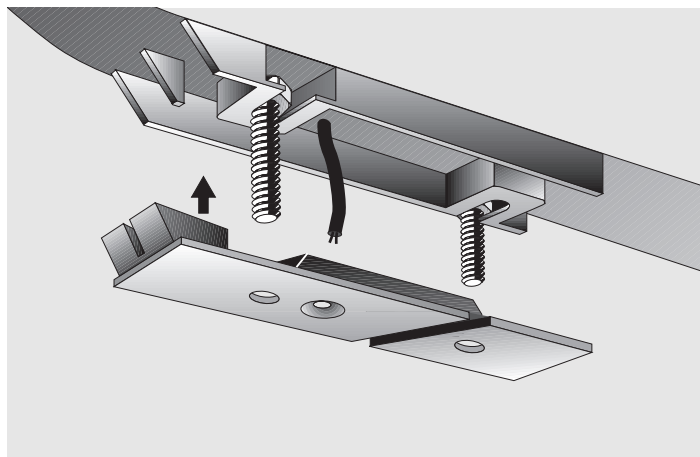

2.1.2 Montage fixe avec grande semelle en caoutchouc

Vous n'avez pas besoin des joints livrés.

Insérez les vis de fixation M 10 dans les entretoises de fixation des supports à droite et à gauche.

Fixez la semelle en caoutchouc sur la face inférieure du système OWS.

Placez l'appareil sur le toit du véhicule. Faites passer le câble par le passe-câble et les vis dans les trous percés.

Vissez ensuite fermement le système OWS.

Après la fixation, contrôlez si les feux rotatifs sont bien à la verticale. Il est possible de corriger le niveau en jouant sur le serrage des vis de fixation.

Respectez la visibilité requise sur 360°.

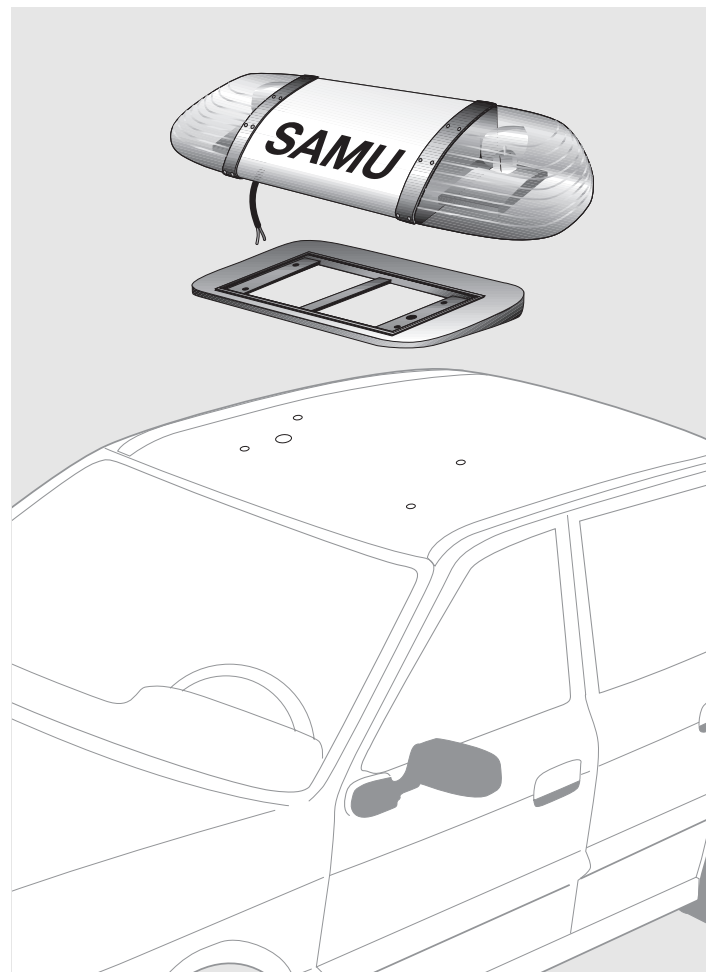

2.2 Montage par étriers-tendeurs

(voir accessoire, point 6.0)

La fixation par étriers-tendeurs est une alternative au montage fixe. A cette fin, seul le trou nécessaire au câble doit être percé. Enfoncez les joints en caoutchouc fournis dans la platine de montage du système OWS.

Vissez le système de fixation 9DX 857 445-001 sous le support.

Vissez maintenant ce système sous l' OWS avec le joint en caoutchouc.

Les étriers-tendeurs doivent être adaptés au type de véhicule respectif.

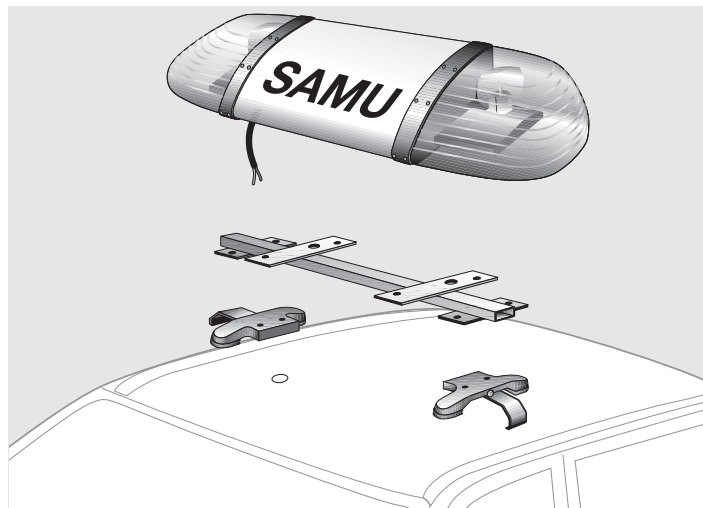

2.3 Montage magnétique

L'OWS 540 à embase magnétique permet de changer rapidement l'unité complète.

A monter uniquement sur des toits en tôle !

La surface de montage doit être exempte de saleté, d'eau, de glace, de neige, de feuilles, etc.

Pour le branchement électrique à la prise auto DIN le câble peut être passé au travers de la fenêtre entrouverte comme illustré. Faire attention de ne pas coincer ni plier le câble.

En cas de non-utilisation s'assurer que l'unité du feu rotatif est entreposée dans le véhicule de manière à ne gêner ni le conducteur ni le passager lors de la conduite !

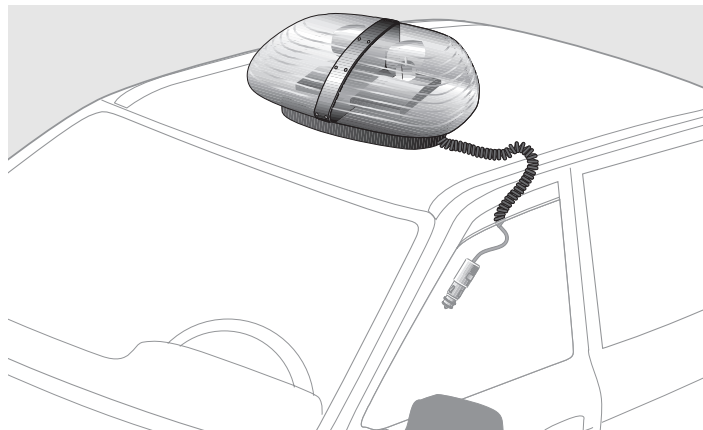

IMPORTANT : Vitesse maximale admissible 120 km/h

3.0 Connexion électrique

La batterie du véhicule doit être déconnectée avant de procéder au montage. Le faisceau de câbles doit de préférence être guidé le long du montant de porte du

véhicule vers l'avant. Veillez à ne pas trop plier le câble dans les parties angulaires du montant.

Feux rotatifs:
 12 V = 2 x 55 W;
 24 V = 2 x 70 W.
 Posez le fil dans le véhicule, raccourcissez-le à la longueur nécessaire et branchez-le par le commutateur.

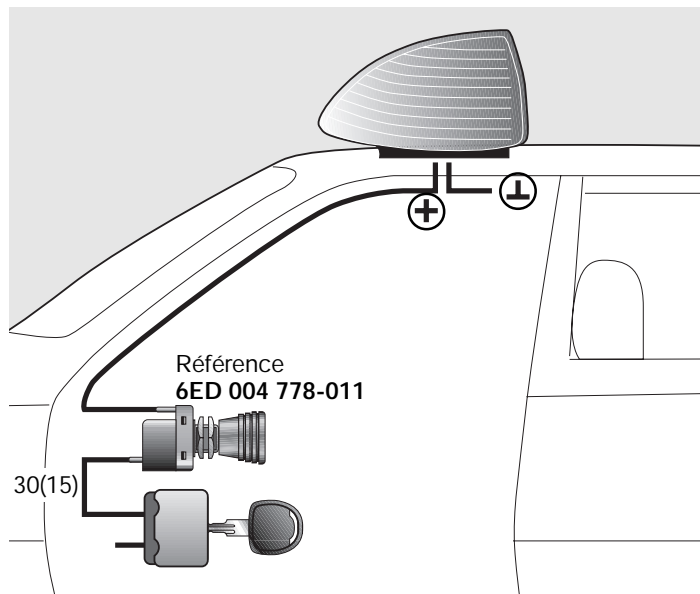

- Fil (+) = blanc (protection par fusible, commutateur avec lampe témoin (voir pièces de rechange)
- Fil (-) = bleu
- Equipement ultérieur p. ex. éclairage intérieur: noir marron

4.0 Caractéristiques techniques

Caractéristiques techniques pour OWS Hella

Caractéristiques techniques générales	
Largeur	~ 300 mm
Hauteur (sans semelle)	~ 180 mm
Poids :	
OWS 540	~ 3,0 kg
OWS 1000	~ 5,5 kg
OWS 1400	~ 7,0 kg
OWS 1600	~ 8,0 kg
Type de protection : IP 5K4K9K (lavage à haute pression)	
Température de fonctionnement :	- 40 °C bis + 60 °C
Température de stockage :	- 40 °C bis + 85 °C
Tension de service :	(U _N) 12 V und 24 V
Plage de tension de service :	
12 V	10...15,5 V
24 V	20...31,0 V
Puissance absorbée : feux rotatifs	
	2 x 4,7 A (12 V)
	2 x 2,7 A (24 V)
Eclairage caisson	-4 A (12 V) -2 A (24 V)

Caractéristiques techniques des systèmes optiques

Entraînement: entraînement à vis

Régime nominal: 160 t/mn

Réflecteur parabolique métallisé argent avec lampe à la verticale (version orange)

Réflecteur parabolique métallisé avec lampes intégrées (version bleue)

Lampe H1:
halogène 12 V / 55 W; 24 V / 70 W

Caisson : PMMA blanc opaque

Cabochoon : orange = PC
bleu = PMMA

Antiparasitage selon VDE 879, partie 3

Degré d'antiparasitage 5

Antiparasitage de proximité pour véhicules.

Homologation: bleu B1 E1 00817
orange A1 E1 00774
CE e1 021309

5.0 Modèles d'appareil / Pièces de rechange

Système complet

Type OWS	Version	Référence
OWS-540	12 V, 2FR, orange	2RL 007 900-501
OWS-540	12 V, 2FR, bleu	2RL 007 900-551
OWS-540	24 V, 2FR, orange	2RL 007 900-511
OWS-540	24 V, 2FR, bleu	2RL 007 900-561
OWS-540 Magnétique	12 V, 2FR, orange	2RL 007 900-521
OWS-540 Magnétique	12 V, 2FR, bleu	2RL 007 900-571
OWS-1000	12 V, 2FR, orange	2RL 007 900-001
OWS-1000	12 V, 2FR, bleu	2RL 007 900-151
OWS-1400	12 V, 2FR, orange	2RL 007 900-201
OWS-1400	24 V, 2FR, orange	2RL 007 900-211
OWS-1400	12 V, 2FR, bleu	2RL 007 900-251
OWS-1600	12 V, 2FR, orange	2RL 007 900-601
OWS-1600	24 V, 2FR, orange	2RL 007 900-611
OWS-1600	12 V, 2FR, bleu	2RL 007 900-651

Pièces de rechange

Cabochon orange gauche		9EL 861 912-001
Cabochon orange droit		9EL 861 913-001
Cabochon bleu gauche		9EL 861 912-021
Cabochon bleu droit		9EL 861 913-021
Moteur		9MN 860 677-021
Réflecteur (orange)		9DX 861 872-001
Réflecteur (bleu)		9DX 861 976-001
Lampe halogène		
12 V-55 W		8HG 002 089-131
24 V-70 W		8HG 002 089-251

6.0 Accessoires

Semelle caoutchouc

Les semelles en caoutchouc sont adaptées de série aux quatre modèles OWS et fabriquées à partir d'une matière écologique et résistant aux intempéries.

La semelle assure une adaptation parfaite de l'OWS sur le toit du véhicule, sans abrasion et sans vibrations.

OWS 540 Semelle en caoutchouc

Longueur: 320 mm
Référence
9GD 862 086-001

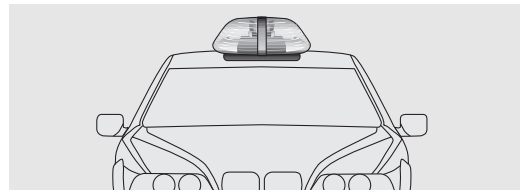
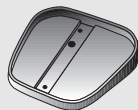

OWS 1000

Longueur: 751 mm
Référence
9GD 862 080-001

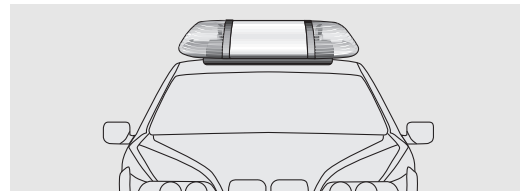
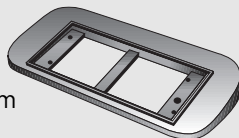

OWS 1400

Longueur: 1151 mm
Référence
9GD 862 081-001

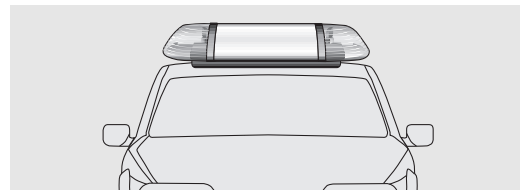
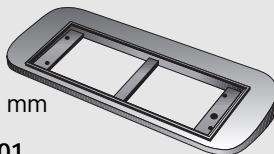

OWS 1600

Longueur: 1351 mm
Référence
9GD 862 085-001

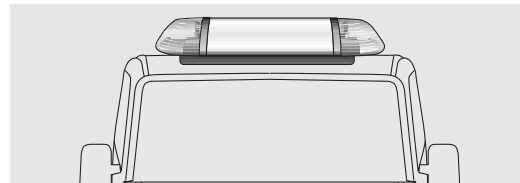
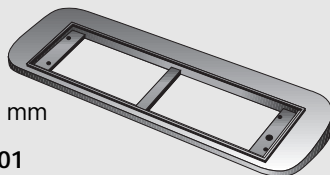

Accessoires

Système de fixation

Le système de fixation se compose de deux éléments et est directement soudé sur un support existant.

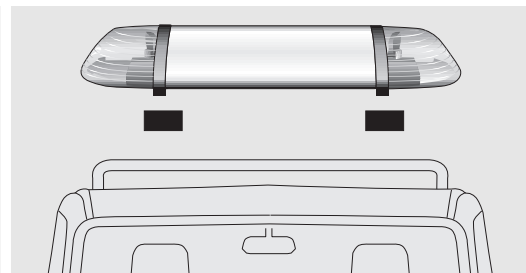
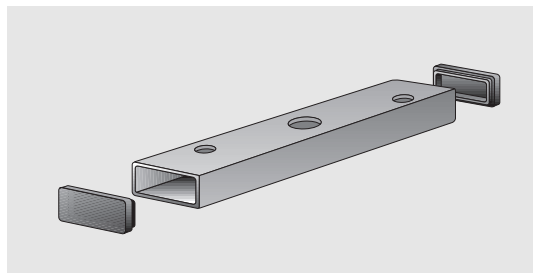

Système de fixation pour montage direct

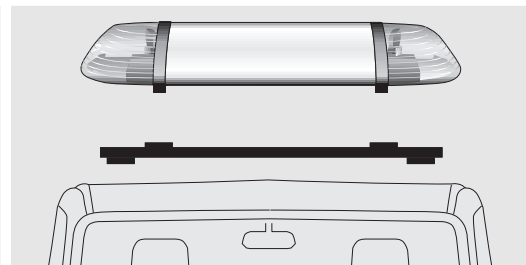
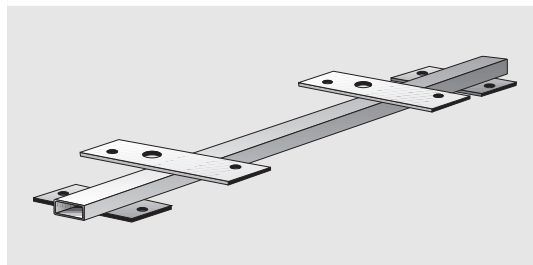

Système de fixation 9DX 857 445-001

Etrier-tendeur
9XD 857 421-801

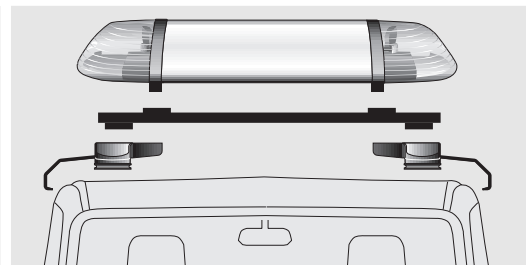
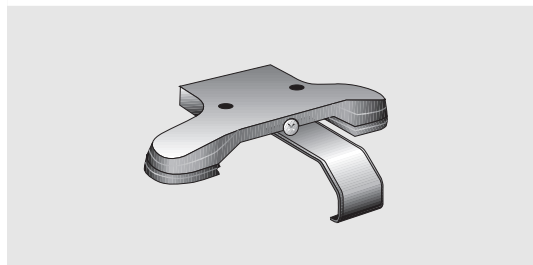

Support de lampe (lampes incluses)

Équipement: OWS 1000 (1 x)
OWS 1400 (2 x)
OWS 1600 (2 x)

Référence

9FT 861 790-001 12 V

9FT 861 790-011 24 V

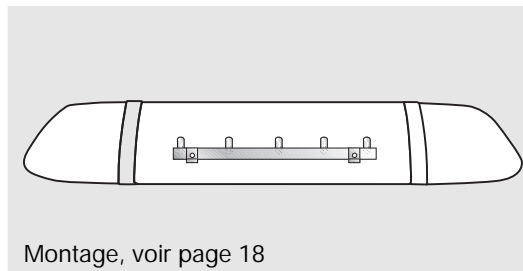
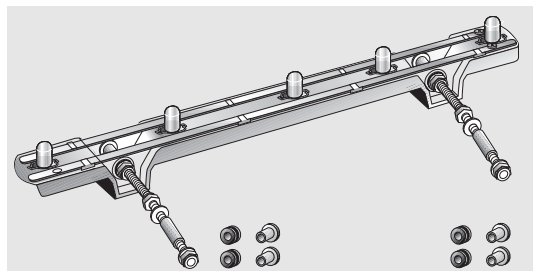

Montage, voir page 18

Lampes (pièces de rechange)

Éclairage du caisson
5 x 5 W ou 10 x 5 W
équipement ultérieur.

Référence

9GP 003 594-131 12 V

9GP 003 594-251 24 V

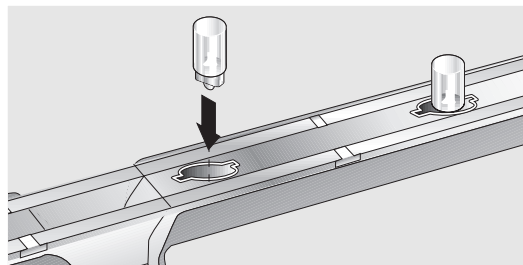
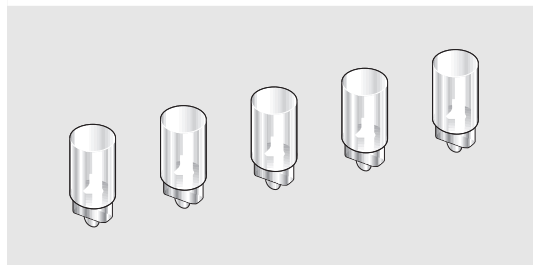

Interrupteur à lampe témoin

respect. 1 unité
pour éclairage intérieur
respect. 1 unité
pour fonctionnement feu
de signalisation

Référence

6ED 004 778-011

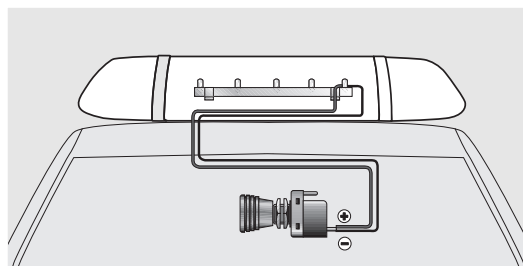
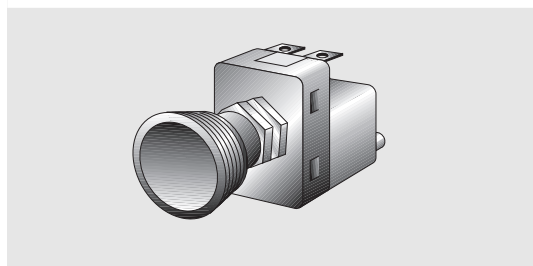

Accessoires

Montage du système d'éclairage du caisson

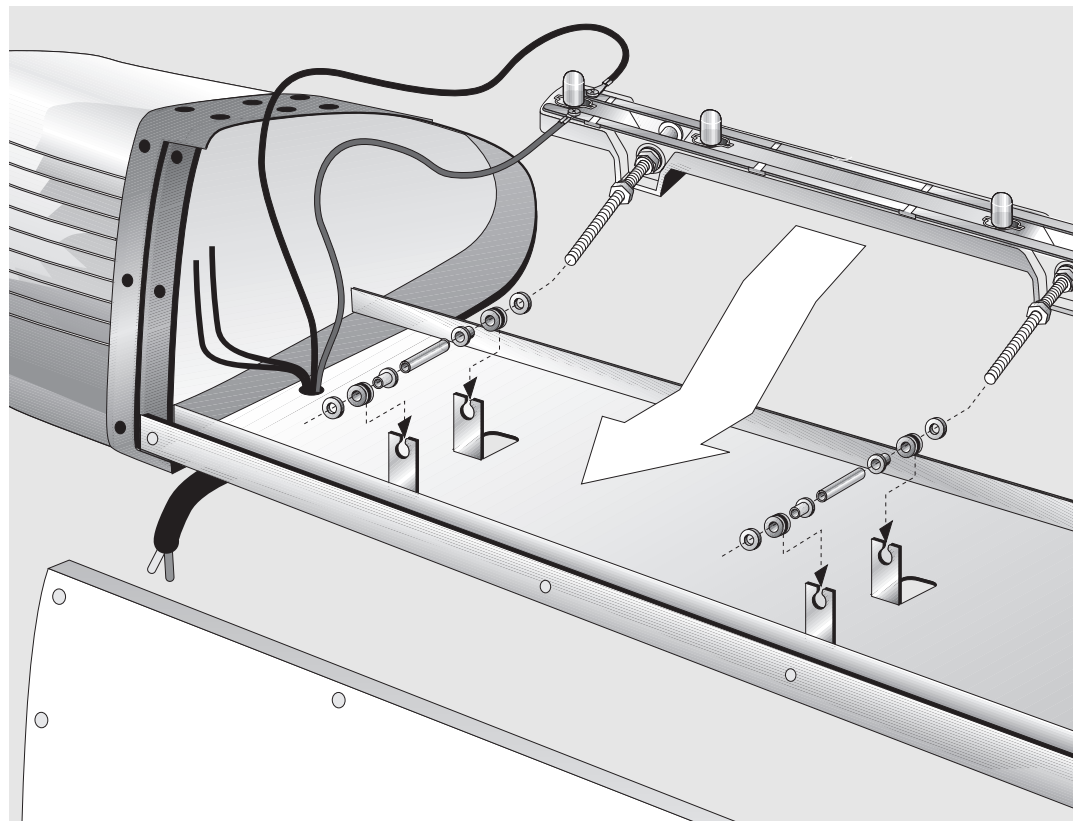

7.0 Détection des défaillances

Feu rotatif

Feu rotatif	Cause possible	
Un ou les deux feux rotatifs sont sans lumière alors que le réflecteur tourne.	Contrôler si la lampe est défectueuse.	
Le réflecteur ne tourne pas, bien que les lampes soient en bon état.	Contrôler si le moteur ou l'entraînement est défectueux.	
Les deux feux rotatifs sont sans lumière, les réflecteurs ne tournent pas.	Contrôler si la tension de bord est disponible à l'entrée ou à la sortie de la boîte à fusibles	oui = Contrôler si la tension est disponible aux bornes 72 (moteur).
		non = Fil d'alimentation 30 allant de la boîte à fusibles ou fusible défectueux.
	Contrôler le passage du fil de masse allant aux feux de signalisation.	

Eclairage du caisson

Dérangement	Cause possible	
Inscriptions partiellement éclairées.	Contrôler si la lampe ou le fusible est défectueux.	

Pour tous renseignements ou problèmes de montage, veuillez s.v.p. contacter votre revendeur habituel.

Hella OWS optiskt varningssystem

Teknisk handbok

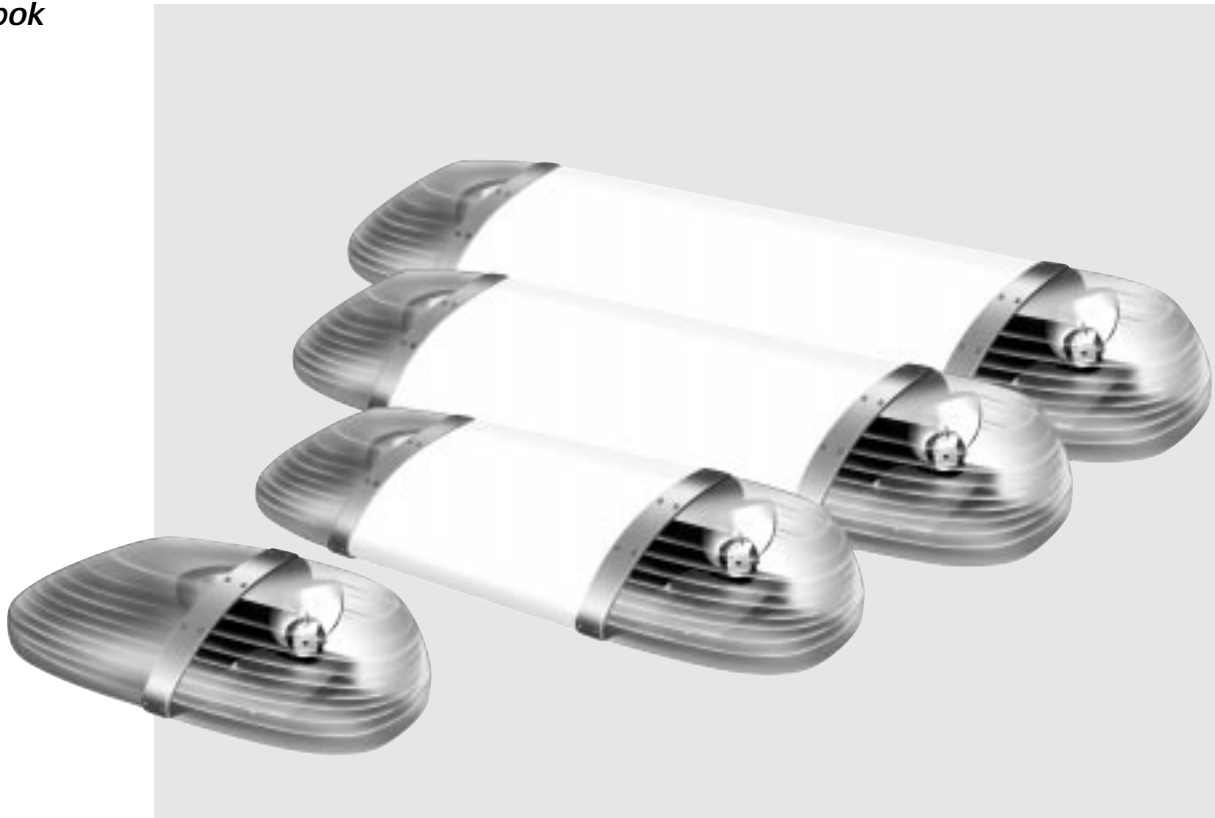

Läs hela denna monterings- och bruksanvisning innan du påbörjar monteringen och följ noga den angivna monteringsföljden. En felaktigt utförd montering kan äventyra fordonets driftsäkerhet.

Teknisk handbok

Hella OWS optiskt varningssystem

Innehållsförteckning

	Sidan
1.0 Allmän information	64
2.0 Montering	66
3.0 Elektrisk anslutning	72
4.0 Tekniska data	73
5.0 Varianter / reservdelar	74
6.0 Tillbehör	75
7.0 Felsökning	79

1.0 Allmän information

System och funktioner

Hella OWS är ett kompakt system för väghållningsfordon,

bärningsfordon, fordon med överlängd eller överbredd. Den är utrustad med gula varningsfyror och med en från

insidan upplysbar yta lämpad för individuell text.

Hella OWS består av delarna:

- Gula varningsfyror, (två 360°-varningsfyror med roterande reflektor och H1 halogenglödlampor).
- Textyta (som tillbehör för upplysning finns glödlampsatser med fem resp. tio parallellkopplade gödlampor).

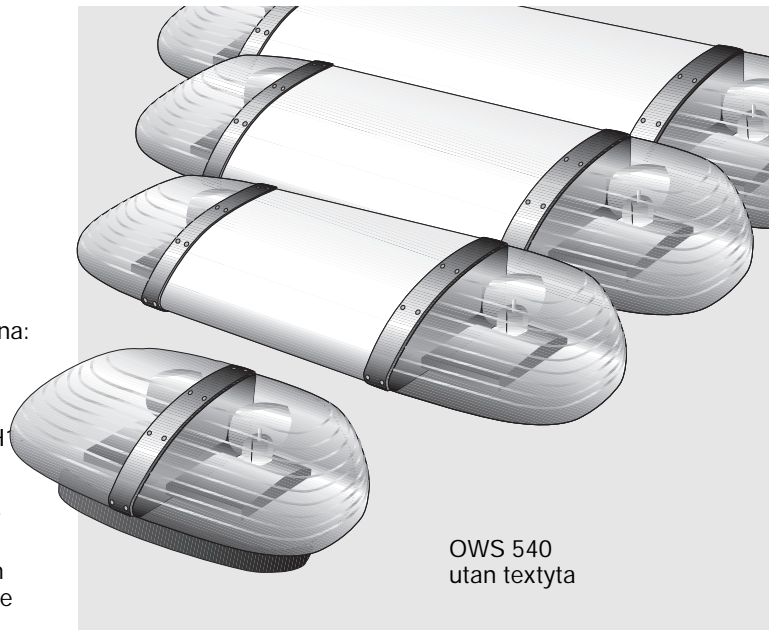

OWS 540
utan textyta

Mångsidighet

Hella OWS har många användningsområden. Text- och reklam möjligheterna ökar mångsidigheten och förbättrar det professionella intrycket.

De stora ytorna ger många möjligheter till textutformning.

De främre och bakre panelerna kan enkelt förses med text och reklamtryck.

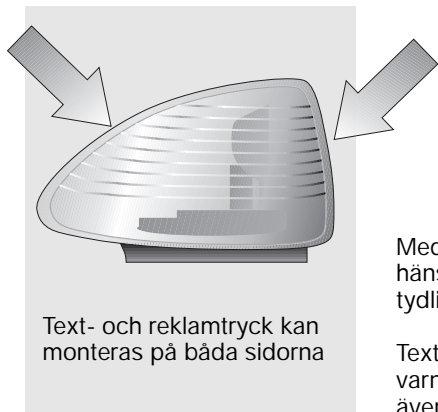
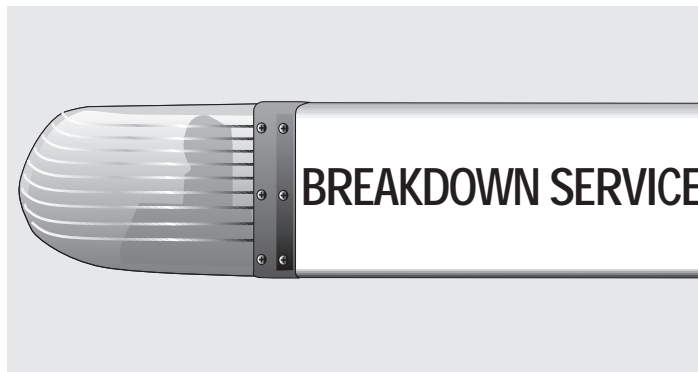

Text- och reklamtryck kan monteras på båda sidorna

Medtrafikanterna tar större hänsyn till ett fordon som syns tydligt.

Texten syns bra inom de båda varningsfyrrarnas ljuskäglor även vid dåligt väder.

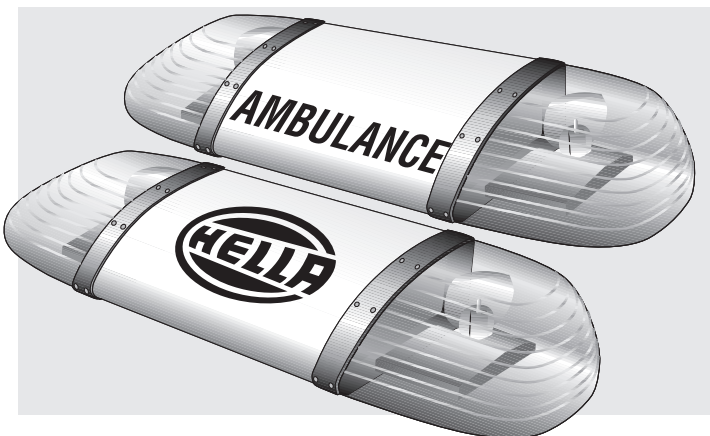

2.0 Montering

Kontrollera före montering med fordonstillverkaren om en takförstärkning är nödvändig.

Bestäm monteringsyta på fordonstaket och förbered monteringen beroende på monteringsätt.

Observera:

Efter varje montering och före varje körning skall anläggningen kontrolleras med avseende på korrekt infästning och fastsittande spännen.

2.1 Fast montering

Markera OWS konturer på taket, enligt måttskissen. Beakta därvid takets välvning. Anligningsytan måste vara fri från snö, is och smuts.

Lossa fordonets innertak. Borra enligt måttskissen. För in den förberedda anslutningsledningen genom ledningsöppningen.

Se vid borrning noga till att underliggande fordonskomponenter inte skadas. Vi rekommenderar att hål borrade i metall rostskyddas. Ledningsgenomföringshålet bör tätas med tätningsmassa.

Borrschablon
OWS 540

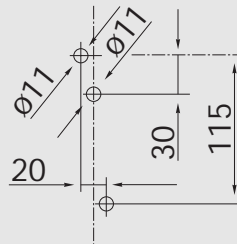

Hålbilden gäller för samtliga typer.

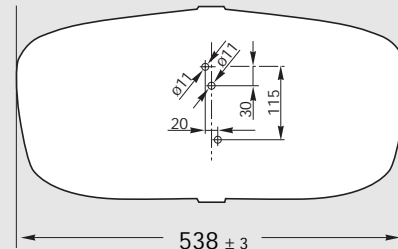

Borrschablon
OWS 1000

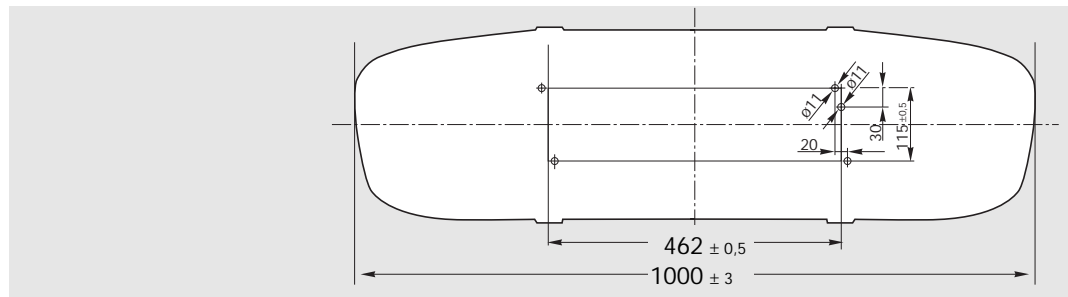

Borrschablon
OWS 1400

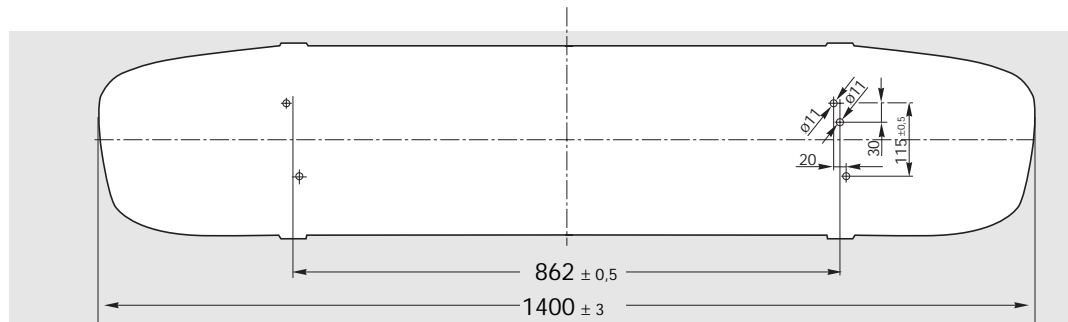

Borrschablon
OWS 1600

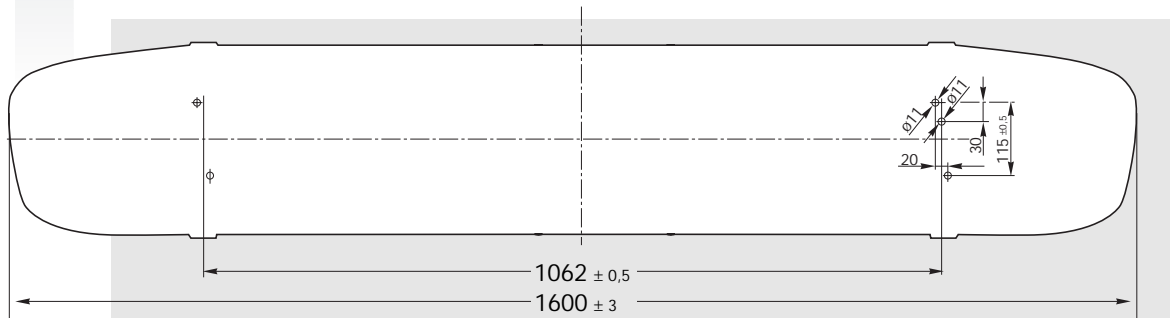

Montering

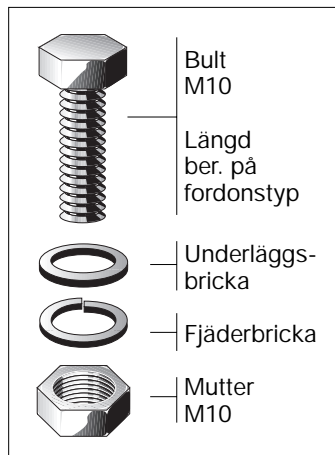

Monteringsmaterialet ingår ej i leveransen.

Fästbultar
M10

Max. åtdragningsmoment :
4 Nm

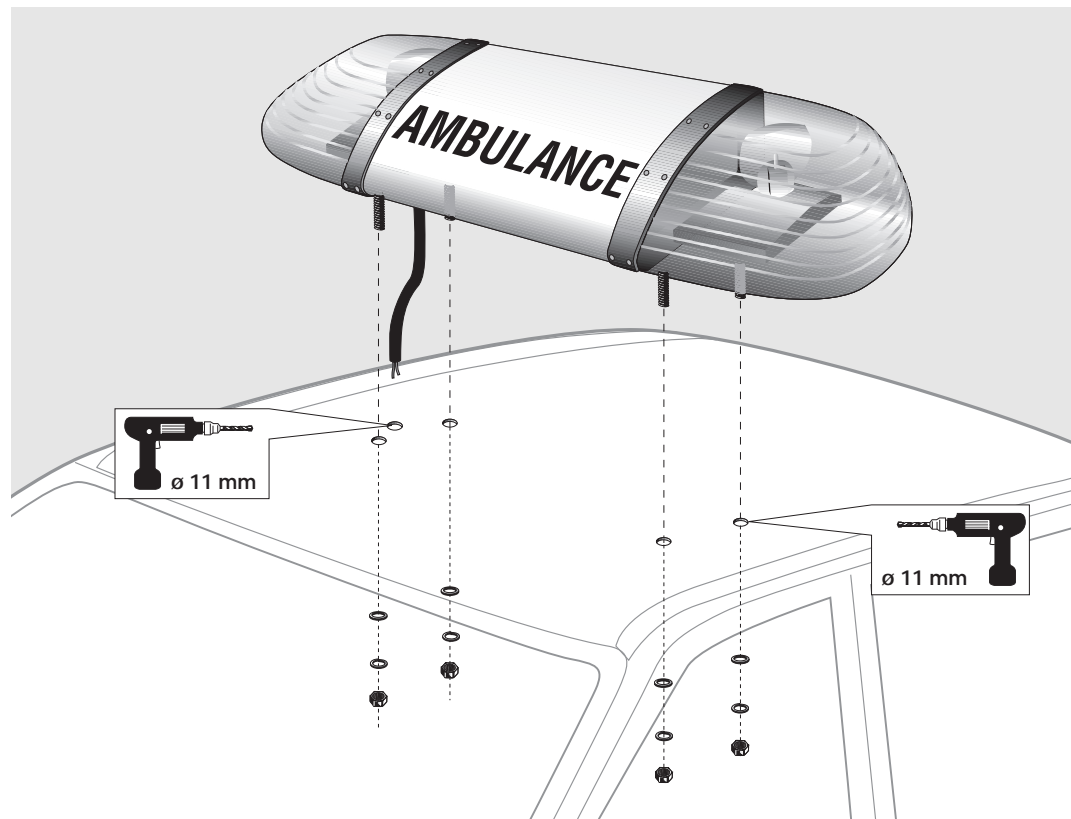

2.1.1 Fast montering med bifogade gummitätningar

(ej möjligt vid OWS 540)

Sätt in fästbultarna M10 till höger och vänster i bärarens fäste.

Tryck in gummitätningarna i monteringsfoten.

För in anslutningsledningen i ledningsöppningen, stick fästbultarna i de borrade hålen i taket, sätt på huset och drag fast.

Kontrollera därefter att varningsfyrrarna står lodrätt.

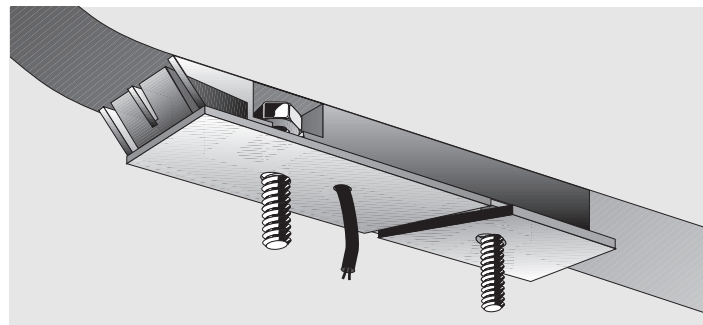
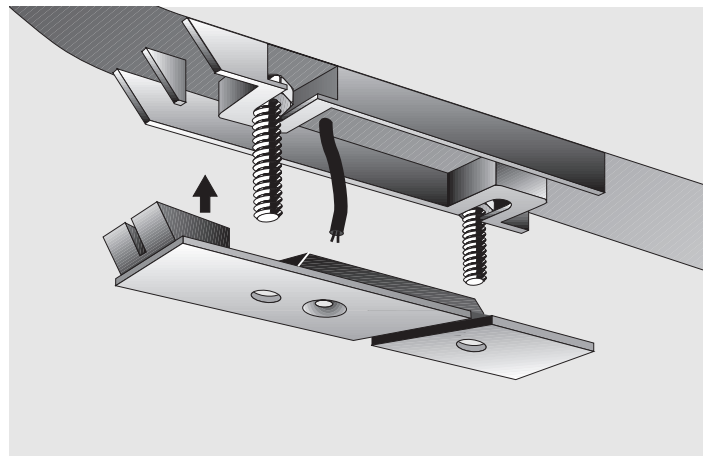

2.1.2 Fast montering med stort gummiunderlägg

De bifogade tätningarna behövs ej.

Sätt in fästbultarna M10 till höger och vänster i bärarens fäste.

Montera gummiunderlägget på OWS undersida.

Placera OWS på fordonstaket. För in ledningen genom ledningsöppningen samt bultarna i de förborrade hålen.

Drag därefter fast OWS.

Kontrollera efter montering att varningsfyrarna står lodrätt. Nivåkorrigering är möjlig genom att fästskruvarna dras åt olika mycket.

Se till att fyrarna är synliga i 360°!



2.2 Spännmontering

(se tillbehör punkt 6.0)

Som alternativ till fast montering är en spännmontering möjlig. Då borras endast ledningsöppningen. De bifogade gummitätningarna trycks in i OWS monteringsfot.

Skruva fast fästsystemet 9DX 857 445-001 under hållaren.

2.3 Magnetmontering

OWS 540 med magnetfäste gör det möjligt att snabbt flytta hela varningsrampen.

Varningsrampen får endast monteras på plåttak!

Monteringsytan måste vara fri från smuts, vatten, is, snö, löv etc.

Varning! Högsta tillåtna hastighet är 120 km/tim!

Detta system skruvas nu fast under OWS med gummitätning.

Spännbyglarna måste anpassas till aktuell fordonstyp.

Den elektriska anslutningen (ledningsdragningen) till DIN-stickdosan (cigarettändaruttaget) kan ske genom ett öppet fönster. Se till att ledningen inte blir klämd eller bryts och att ledningsdragningen inte stör föraren.

När varningsrampen inte används skall den förvaras så att den inte stör föraren eller passagerarna.

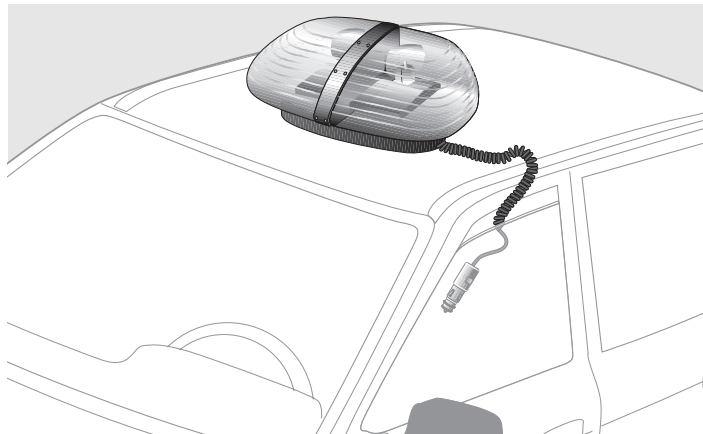
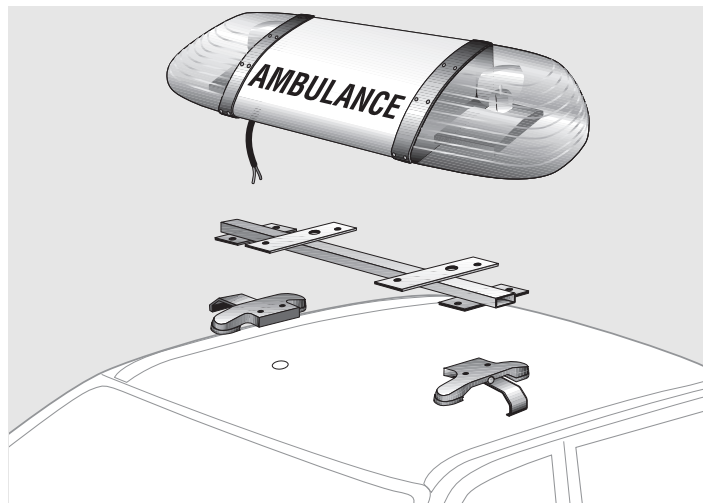

3.0 Elektrisk anslutning

Lossa batteriets minuspol före montering. Kablaget förläggs lämpligen framåt längs fordonets vindrutestolpe. Se till att det inte böjs för hårt över kanter och hörn.

Varningsfyrrar:
 12 V = 2 x 55 W
 24 V = 2 x 70 W
 Förlägg kablagen i fordonet, kapa till rätt längd och anslut via strömbrytare.

- Plusledning = vit (avsäkrad, strömbrytare med kontrollampa, se reservdelar)
- Minusledning = blå
- Tilläggsutrustning t ex innerbelysning: svart, brun

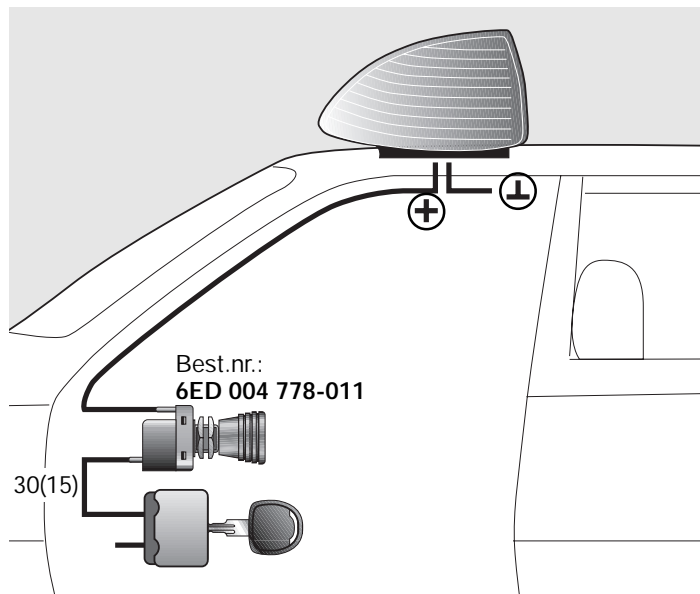

4.0 Tekniska data

Tekniska data för Hella OWS

Allmänna tekniska data	
Bredd	~ 300 mm
Höjd (utan underlägg)	~ 180 mm
Vikt:	
OWS 540	~3.0 kg
OWS 1000	~5.5 kg
OWS 1400	~7.0 kg
OWS 1600	~8.0 kg
Skyddsklass: IP 5K4K9K (högtryckstvätt)	
Drifttemperatur	- 40 °C till + 60 °C
Lagringstemperatur:	- 40 °C till + 85 °C
Drivspänning:	(U _N)12 V och 24 V
Drivspänningsområde	
12 V	10...15.5 V
24 V	20...31.0 V
Strömförbrukning varningsfyrrar	2 x 4,7 A (12 V) 2 x 2,7 A (24 V)
Textskiva belyst	~4 A (12 V) ~2 A (24 V)

Tekniska data för optiska system

Drivning: Snäckdrivning

Varvtal: 160 varv/min

Silverlackerad parabolreflektor med stående glödlampa (gult utförande)

Höglansparabolreflektor med integrerad glödlampa (blått utförande)

H1-glödlampa:
Halogen 12 V / 55 W; 24 V / 70 W



Textskiva (material) PMMA mjölkvitt

Ljuskåpa (material) gul = Makrolon (PC)
blå = PMMA

Radioavstörning enl. VDE 879 del 3

Avstörningsgrad 5

Närvstörning för fordon

Typprovning: blå	B1		00817
gul	A1		00774
CE			021309

5.0 Varianter / reservdelar

Komplett

OWS-typ	Utförande	Best.nr.:
OWS-540	12 V, 2KL, gul	2RL 007 900-501
OWS-540	12 V, 2KL, blå	2RL 007 900-551
OWS-540	24 V, 2KL, gul	2RL 007 900-511
OWS-540	24 V, 2KL, blå	2RL 007 900-561
OWS-540 Magnet	12 V, 2KL, gul	2RL 007 900-521
OWS-540 Magnet	12 V, 2KL, blå	2RL 007 900-571
OWS-1000	12 V, 2KL, gul	2RL 007 900-001
OWS-1000	12 V, 2KL, blå	2RL 007 900-151
OWS-1400	12 V, 2KL, gul	2RL 007 900-201
OWS-1400	24 V, 2KL, gul	2RL 007 900-211
OWS-1400	12 V, 2KL, blå	2RL 007 900-251
OWS-1600	12 V, 2KL, gul	2RL 007 900-601
OWS-1600	24 V, 2KL, gul	2RL 007 900-611
OWS-1600	12 V, 2KL, blå	2RL 007 900-651
Ljuskåpa gul vänster		9EL 861 912-001
Ljuskåpa gul höger		9EL 861 913-001
Ljuskåpa blå vänster		9EL 861 912-021
Ljuskåpa blå höger		9EL 861 913-021
Motor		9MN 860 677-021
Reflektor (gul)		9DX 861 872-001
Reflektor (blå)		9DX 861 976-001
Halogenlödampa		
12 V / 55 W		8HG 002 089-131
24 V / 70 W		8HG 002 089-251

Reservdelar

6.0 Tillbehör

Gummiunderlägg

Gummiunderläggen är anpassade till de fyra OWS-modellerna och tillverkade av miljövänligt, väderbeständigt material.

Underläggen ger OWS en väl tilltagen vibrations- och nötningsbeständig anliggningsyta mot fordonstaket och medverkar dessutom till ett integrerat helhetsintryck.

OWS 540
Gummiunderlägg
standard

Längd: 320 mm
Best.nr.:
9GD 862 086-001

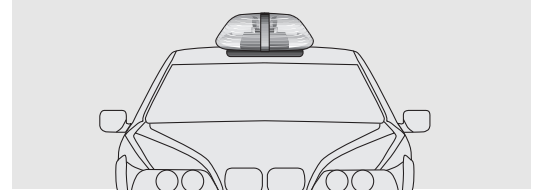

OWS 1000

Längd: 751 mm
Best.nr.:
9GD 862 080-001

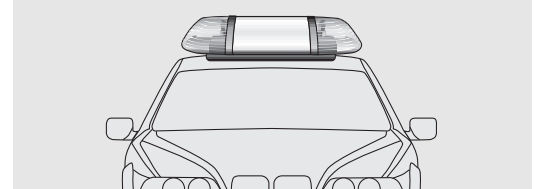
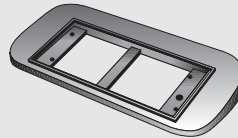

OWS 1400

Längd: 1151 mm
Best.nr.:
9GD 862 081-001

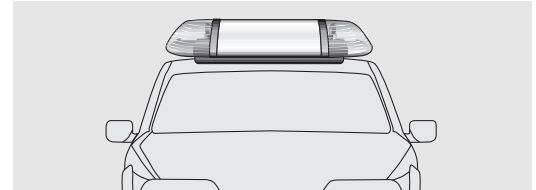
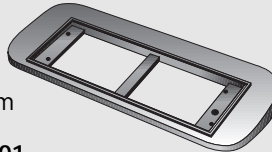

OWS 1600

Längd: 1351 mm
Best.nr.:
9GD 862 085-001

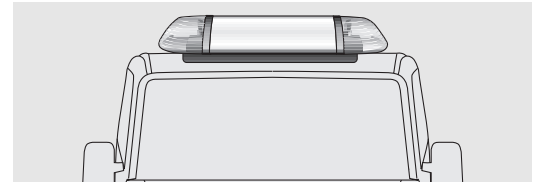
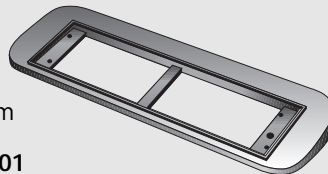

Tillbehör

Bärarsats

Bärarsatsen består av två delar och svetsas direkt mot en redan befintlig hållare.

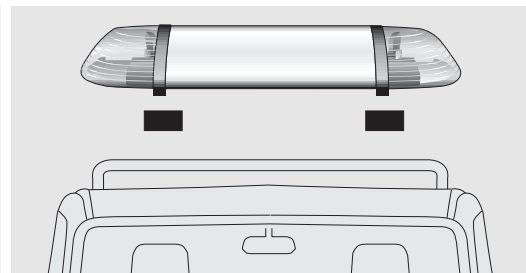
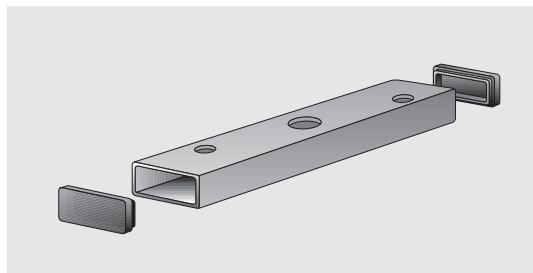

Hållarsats för direktmontering

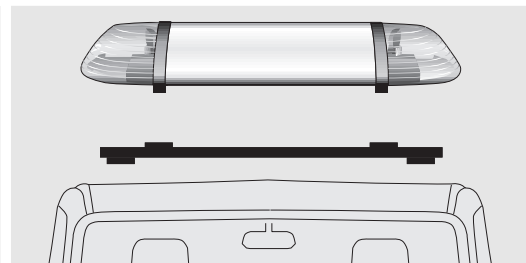
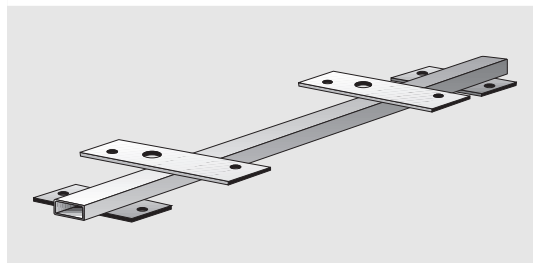

Fäste
9DX 857 445-001

Spännbygel
9XD 857 421-801

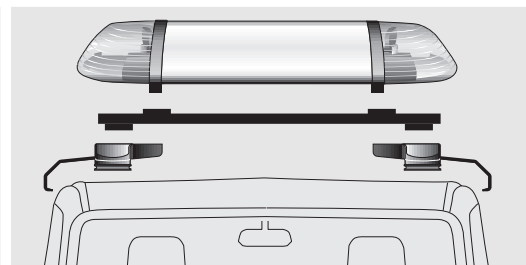
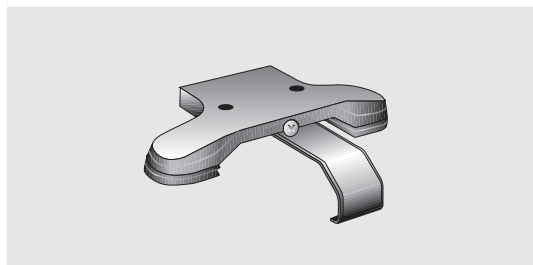

Lamphållare (inkl. lampor)

Bestyckning: OWS 1000 (1 x)
OWS 1400 (2 x)
OWS 1600 (2 x)

Best.nr.:

9FT 861 790-001 12 V

9FT 861 790-011 24 V

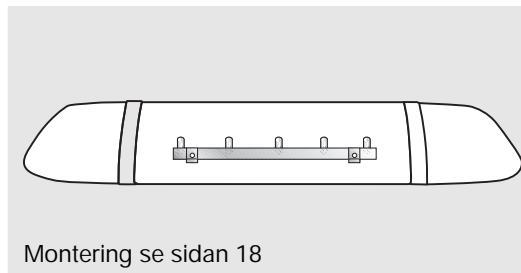
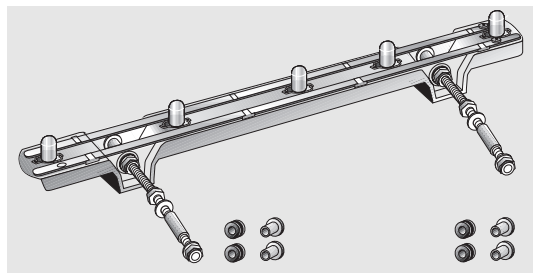

Montering se sidan 18

Lampor (reservdelar)

Textskivebelysning
5 x 5 W resp. 10 x 5 W
tilläggsutrustning

Best.nr.:

12961 12 V

13961 24 V

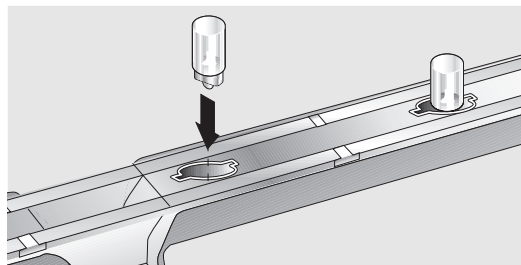
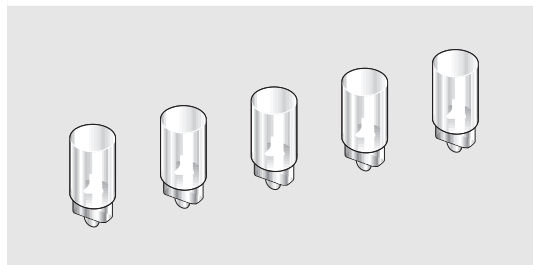

Strömbrytare med kontrollampa

1 st
för innerbelysning

1 st
för varningsfyrdrivning

Best.nr.:

6ED 004 778-011

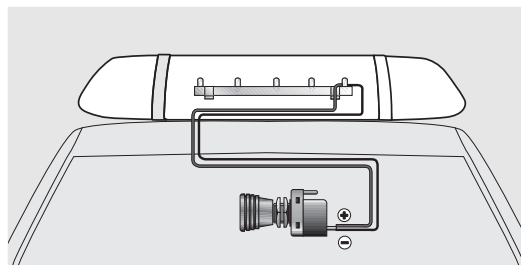
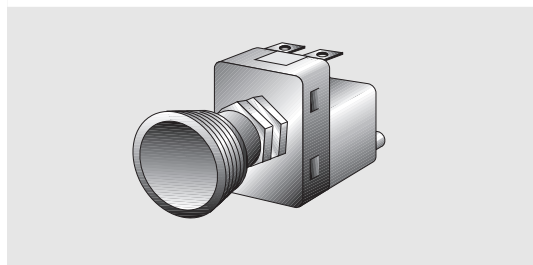

Tillbehör

Montering av textskivebelysning

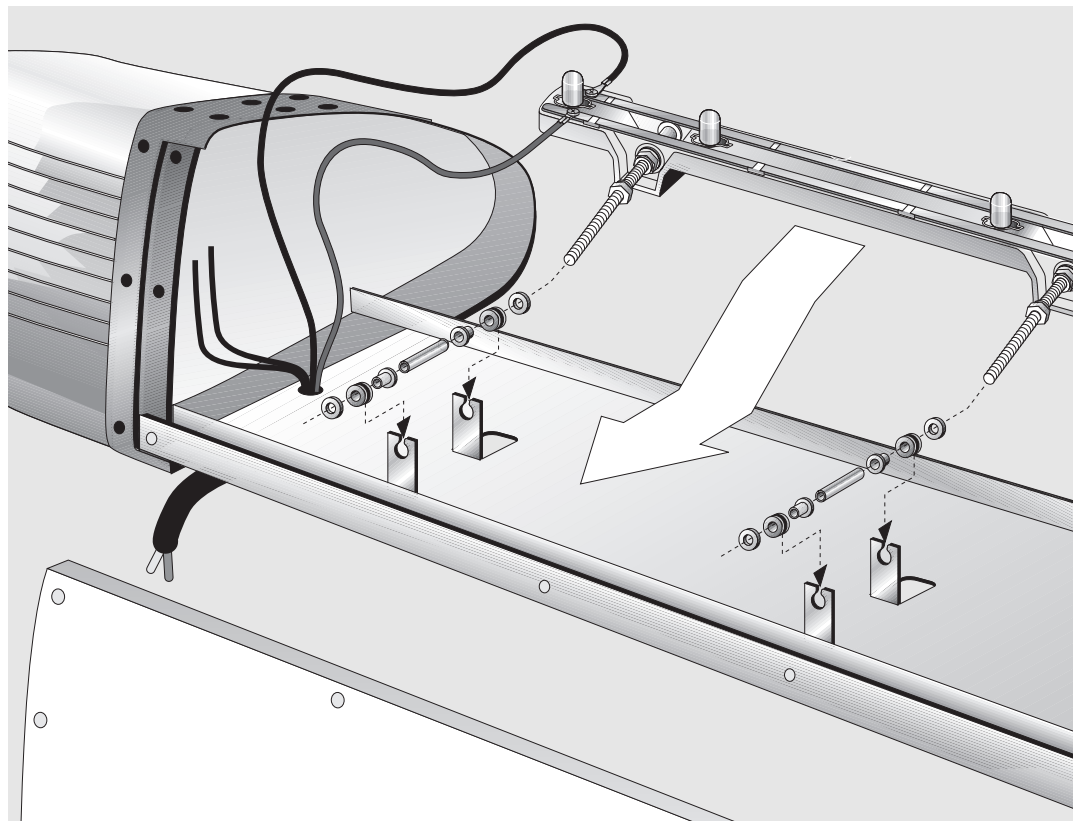

7.0 Felsökning

Varningsfyr

Varningsfyr	Möjlig orsak
En eller båda fyrarna lyser ej vid roterande reflektor	Kontrollera om glödlampan är defekt
Reflektorn roterar ej, glödlampan dock hel	Kontrollera om drivning resp. motor är defekt
Båda fyrarna utan ljus, reflektorerna roterar ej	Kontrollera om spänning finns vid säkringsdosan
	ja = Kontrollera om spänning finns vid klämma 72 (motor)
	nej = Ansl.ledning 30 till säkringsdosa resp. säkring defekt
	Kontrollera om jordledningen till fyrarna är OK

Belysning för textskiva

Störning	Möjlig orsak
Texten ej fullständigt upplyst	Kontrollera om glödlampa eller säkring är defekt

Hella Optisch Waarschuwing Systeem OWS

Technisch handboek

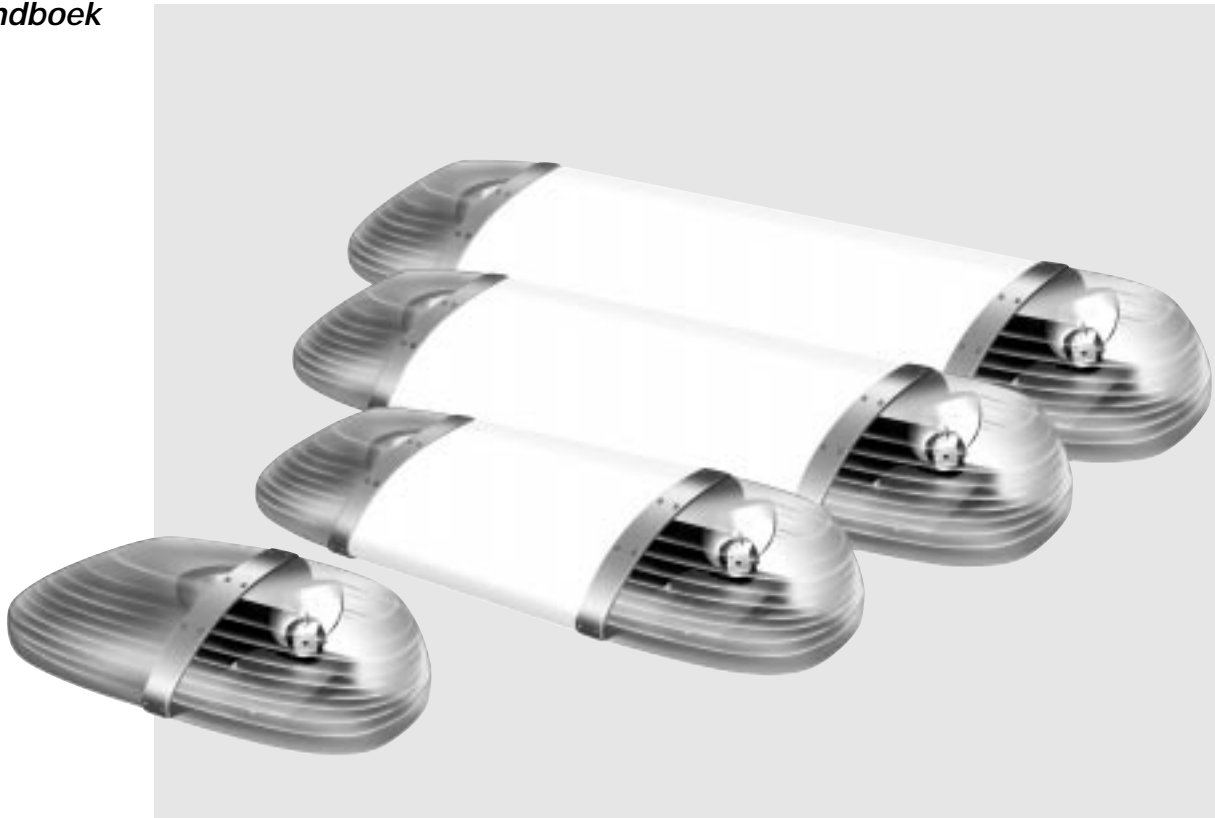

Voordat u met de montage begint eerst de montagehandleiding volledig lezen en bij de montage de aangegeven volgorde volgen. Onjuiste montage kan de bedrijfszekerheid van het voertuig in gevaar brengen.

Technisch handboek

Hella Optisch Waarschuwing Systeem OWS

Inhoud

	Pagina
1.0 <i>Algemene informatie</i>	84
2.0 <i>Montage</i>	86
3.0 <i>Elektrische aansluitingen</i>	92
4.0 <i>Technische gegevens</i>	93
5.0 <i>Uitvoeringen / onderdelen</i>	94
6.0 <i>Accessoires</i>	95
7.0 <i>Foutanalyse</i>	99

1.0 Algemene informatie

Systemen en functies

De Hella OWS is een compact systeem voor officiële voertuigen, zoals sleepdiensten,

wegenbouw, voertuigen met overlengte c.q. overbreedte enz. Het Hella OWS systeem heeft twee zwaailampen. Het witte midden gedeelte kan

worden voorzien van belettering en kan van binnenuit worden verlicht.

De Hella OWS bestaat uit volgende systeemdelen:

- Zwaailampen oranje, (twee 360 graden roteren zwaailampen met halogeen gloeilamp H1).
- Wit reclamevlak voor belettering dat van binnenuit kan worden verlicht (vijf of tien parallel geschakelde gloeilampen, separaat te bestellen).

*) Het van binnenuit verlichtbare reclamevlak is in Oostenrijk en Zwitserland niet toegestaan.

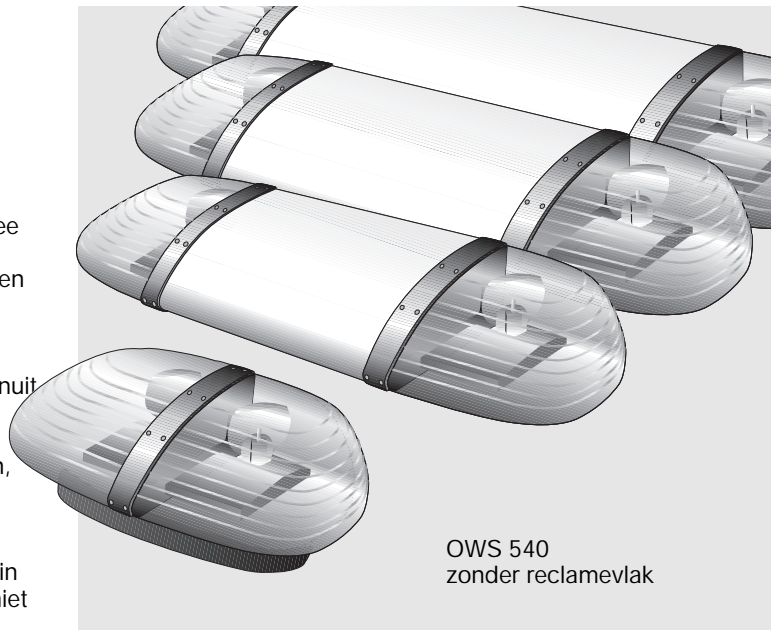

OWS 540
zonder reclamevlak

Veelzijdige inzetbaarheid

Zo veelzijdig als de inzetbaarheid van het OWS systeem zo veelzijdig zijn de ook de mogelijkheden voor belettering.

Het grote witte glas van het reclamevlak geeft vele mogelijkheden voor belettering.

De gewenste belettering kan probleemloos aan zowel de voorkant als aan de achterkant worden aangebracht.

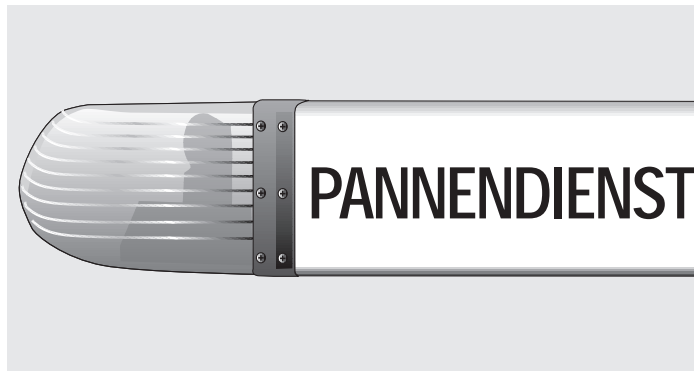

Belettering kan aan beide zijden worden aangebracht.

Als het voertuig duidelijk opvalt, kan men rekenen op een grotere attentiewaarde.

De belettering blijft ook bij slecht weer duidelijk zichtbaar door de uitstraling van beide zwaailampen.

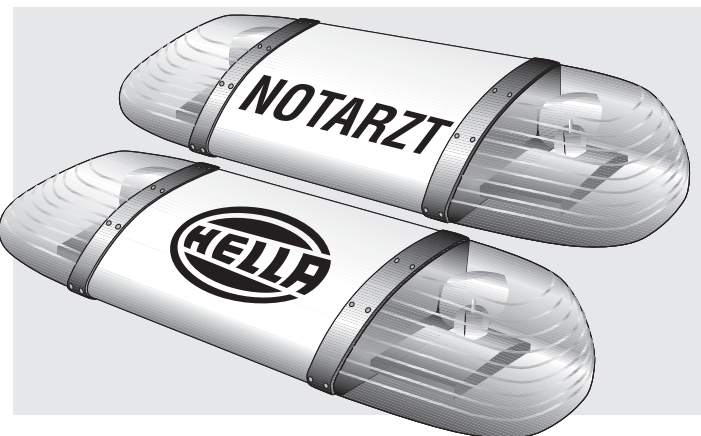

2.0 Montage

Voordat u met de montage begint, bij de producent van het voertuig informeren of er dakversteving noodzakelijk is.

Een vlakke plaats bepalen op het voertuigdak en de montage voorbereiden.

Pas op:

Na de montage en voor elke rit de OWS en de bevestiging controleren of het geheel vast op het dak gemonteerd is.

2.1 Vaste montage

Aan de hand van de maattekening de contouren van de OWS markeren. Hierbij rekening houden met de dakwieling. Het montagevlak moet vrij zijn van sneeuw, ijs en vuil.

De bekleding van het dak in de cabine (hemelbekleding) openen. Gaten volgens de maattekening boren. Aansluitkabel door de kabelopening leiden.

Voor het boren zekerstellen dat er geen onderliggende voertuigdelen beschadigd kunnen worden. Wij adviseren de geboorde gaten te behandelen met een anti roest middel en het gat na de montage dicht te kittten.

Boorsjabloon
OWS 540

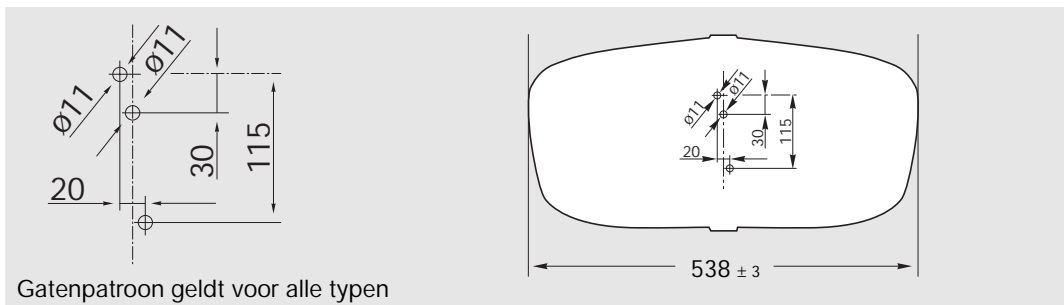

Boorsjabloon
OWS 1000

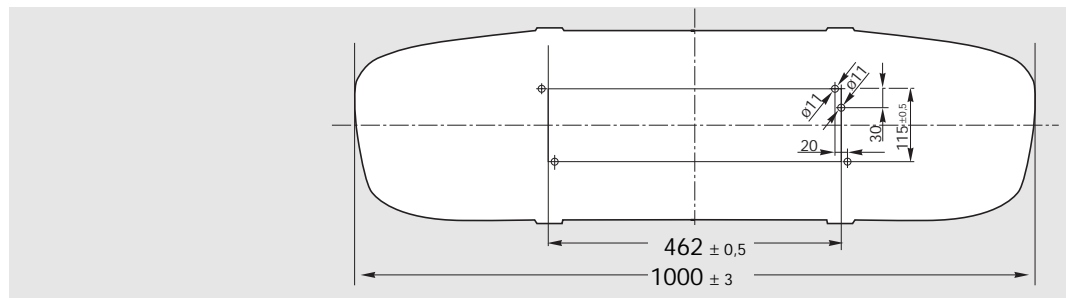

Boorsjabloon
OWS 1400

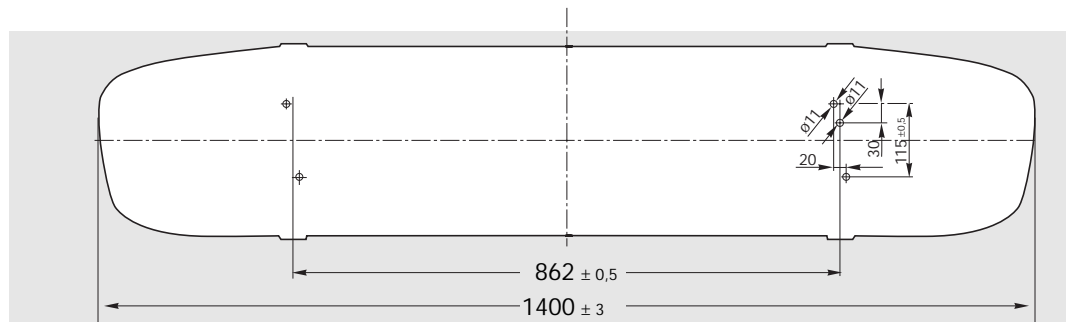

Boorsjabloon
OWS 1600

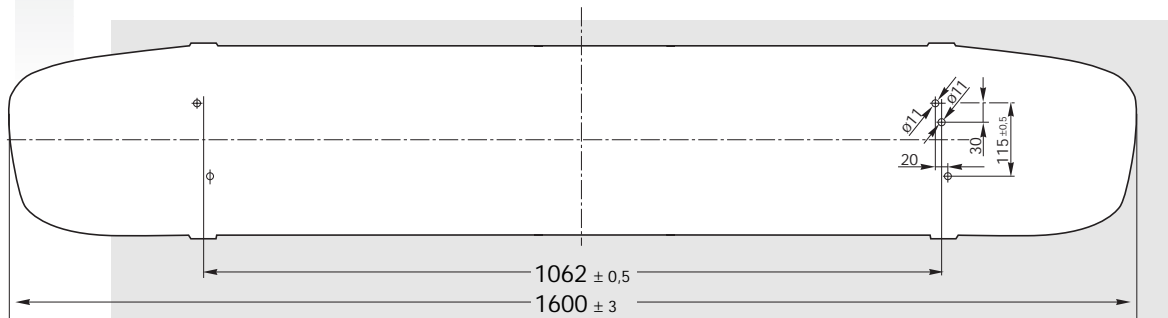

Montage

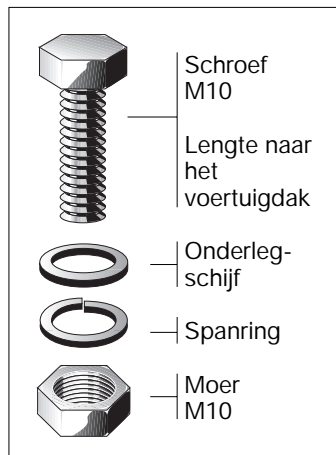

Bevestigingsmateriaal wordt
niet meegeleverd.

Bevestigingsschroef
M10

Max. aandraaimoment
4 Nm

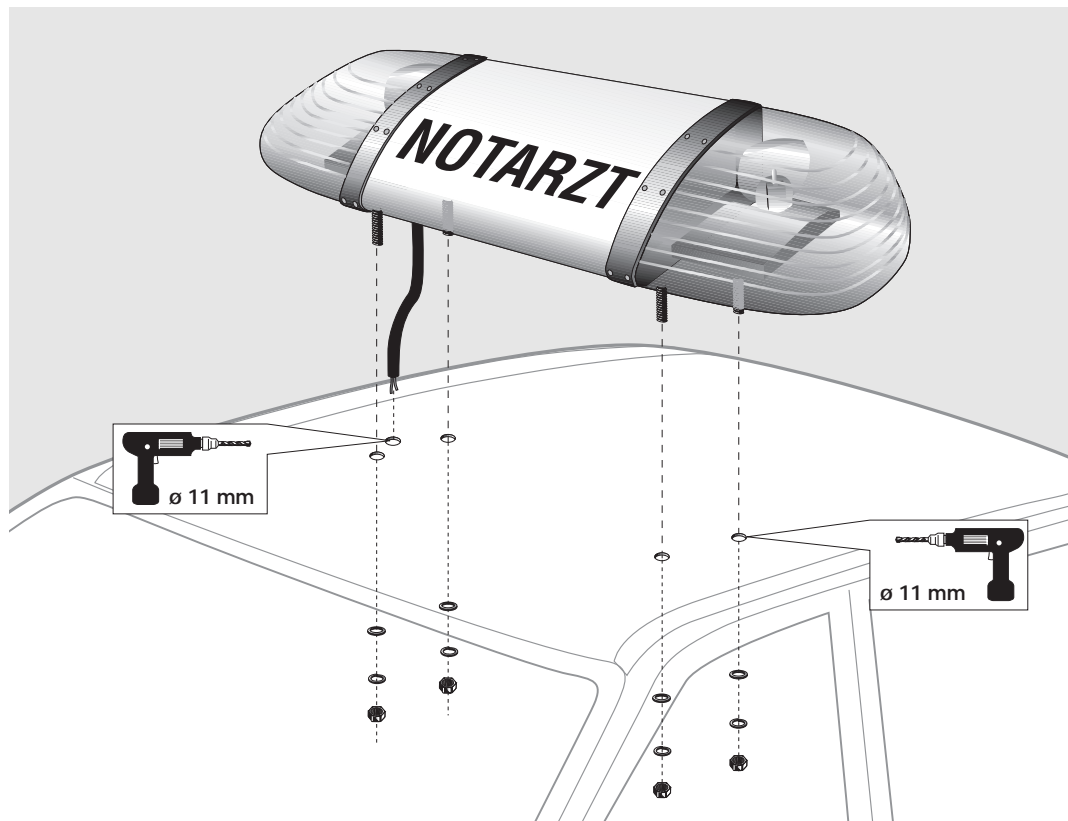

2.1.1 Vaste montage met meegeleverde standaard onderlegrubber.

(niet mogelijk bij de OWS 540)

Bevestigingsschroeven M 10 in de bevestigingsgaten van de drager, links en rechts, monteren.

Onderlegrubber onder de drager drukken.

Aansluitkabel door de kabelopening leiden, de bevestigingsschroeven in de voorgeboorde gaten van het dak steken, de OWS monteren en de schroeven vast schroeven.

Na de bevestiging controleren of de OWS horizontaal staat.

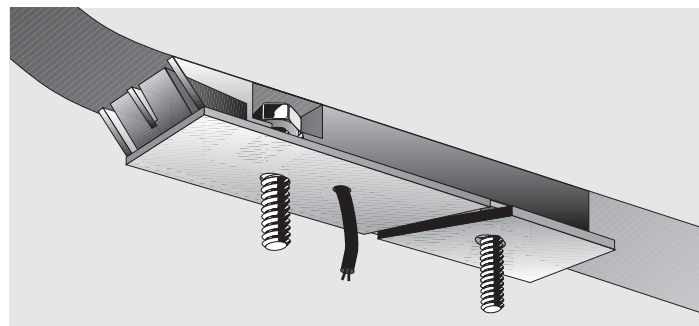
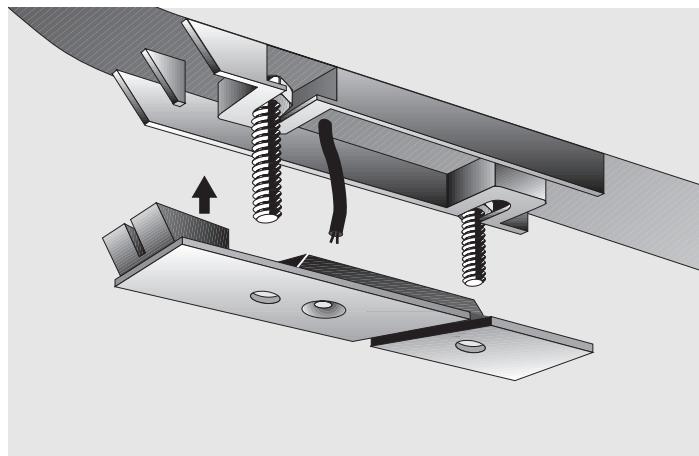

2.1.2 Vaste montage met groot onderlegrubber.

Het standaard onderlegrubber heeft u niet nodig.

Bevestigingsschroeven M 10 in de bevestigingsgaten van de drager, links en rechts, monteren.

Onderlegrubber onder OWS aanbrengen.

De OWS op het voertuigdak zetten. Daarbij de kabel door de kabelopening en de schroeven door de voorgeboorde gaten voeren.

Aansluitend de OWS vast schroeven.

Na de montage controleren of de zwaailampen horizontaal staan, kleine niveau correcties kunnen door het verschillend aandraaien van de bevestigingsschroeven worden gecorrigeerd.

Op de zichtbaarheid 360° letten.



2.2. Spanmontage

(zie accessoires pt. 6.0)

Als alternatief voor vaste montage is een spanbevestiging mogelijk. Daarvoor wordt alleen een gat geboord voor de kabel. De meegeleverde rubbers in de montagevoet van de OWS drukken.

Bevestigingssysteem 9XD 857 445-001 onder de houder schroeven.

Dit systeem onder de OWS met de rubbers schroeven.

De spanbeugel moet aan het voertuigtype worden aangepast.

2.3 Magneetmontage

De OWS 540 met magneetvoet maakt een snelle montage van de gehele lichtbak mogelijk. De lichtbak mag alleen op stalen daken worden geplaatst! Het montagevlak moet vrij van vuil, water, ijs, sneeuw, bladeren enz. zijn.

Opgelet! Max. toelaatbare maximumsnelheid 120 km/h!

De elektrische aansluiting (kabeldoorvoer) naar de DIN contactdoos van de auto kan door het geopende zijraam worden gevoerd. Daarbij moet men erop letten, dat de aansluitkabel niet knelt of knikt.

Bij niet-gebruik de lichtbak zo in het voertuig bewaren, dat gedurende de rit geen hinder voor de chauffeur en de bijrijder kan ontstaan!

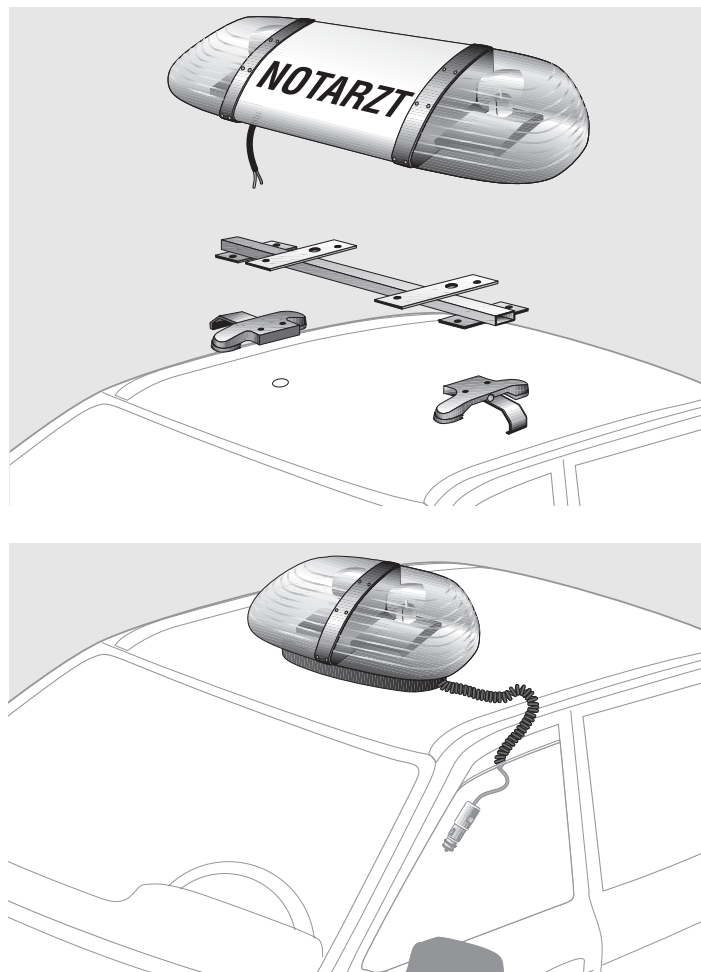

3.0 Electrische aansluiting

De accuklemmen voor de montage demonteren. Het kabelset is het beste via de voorruitstijl van het voertuig naar voren te voeren. Daarbij mag de kabel niet worden geknikt en scherpe kanten moeten worden vermeden.

Zwaailampen:
 12 V = 2 x 55 W;
 24 V = 2 x 70 W.
 De kabel in het voertuig aanleggen, op lengte afsnijden en via de schakelaar aansluiten.

- + kabel = wit (zekeren, schakelaar met controlelamp (zie accessoires))
- - kabel = blauw
- Montage achteraf b.v. verlichting voor belettering: zwart, bruin.

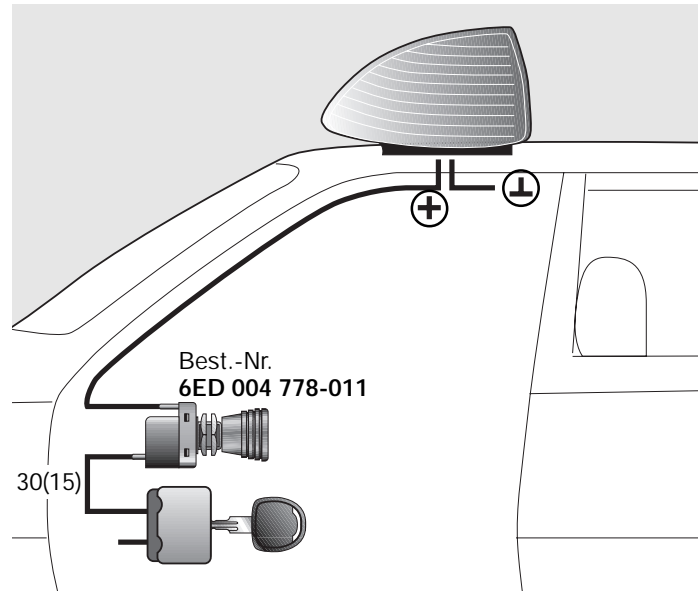

4.0 Technische gegevens

Technische gegevens voor de Hella OWS

Algemene technische gegevens	
Breedte	~ 300 mm
Hoogte (zonder rubber)	~ 180 mm
Gewicht:	
OWS 540	~ 3,0 kg
OWS 1000	~ 5,5 kg
OWS 1400	~ 7,0 kg
OWS 1600	~ 8,0 kg
Beveiliging: IP 5K4K9K (Hogedrukreiniger)	
Bedrijfstemperatuur:	- 40 °C tot + 60 °C
Houdbaarheidtemp.	- 40 °C tot + 85 °C
Bedrijfsspanning	(U _N)12 V en 24 V
Bedrijfsspanningsbereik:	
12 V	10...15,5 V
24 V	20...31,0 V
Stroomafname	
Zwaailampen	2 x 4,7 Amp (12 V) 2 x 2,7 Amp (24 V)
Verlichting belettering:	
	~4 Amp (12 V) ~2 Amp (24 V)

Technische gegevens zwaailampen

Aandrijving: wormwiel

Omwentelingen: 160 min⁻¹

Zilverkleurige parabool reflector met staande gloeilamp(oranje uitvoering)

Paraboolreflector met hoogglans en staande gloeilamp (blauwe uitvoering)

H1-gloeilamp:
Halogen 12 V / 55 W; 24 V / 70 W

Beletteringsglas: (materiaal) PMMA melkwit

Glaskap: (materiaal) Oranje = PC
Blauw = PMMA

Ontstoring VDE 879 deel 3

Ontstoringgraad 5

Nahentstörung für Kfz.

Type goedkeuring: Blauw B1 E1 00817
Oranje A1 E1 00774
CE e1 021309

5.0 Uitvoeringen / onderdelen

Compleet systeem

OWS-Type	Uitvoering	Bestelnummer
OWS-540	12V, 2x KL, oranje	2RL 007 900-501
OWS-540	12V, 2x KL, blauw	2RL 007 900-551
OWS-540	24V, 2x KL, oranje	2RL 007 900-511
OWS-540	24V, 2x KL, blauw	2RL 007 900-561
OWS-540 Magneet	12V, 2x KL, oranje	2RL 007 900-521
OWS-540 Magneet	12V, 2x KL, blauw	2RL 007 900-571
OWS-1000	12V, 2x KL, oranje	2RL 007 900-001
OWS-1000	12V, 2x KL, blauw	2RL 007 900-151
OWS-1400	12V, 2x KL, oranje	2RL 007 900-201
OWS-1400	24V, 2x KL, oranje	2RL 007 900-211
OWS-1400	12V, 2x KL, blauw	2RL 007 900-251
OWS-1600	12V, 2x KL, oranje	2RL 007 900-601
OWS-1600	24V, 2x KL, oranje	2RL 007 900-611
OWS-1600	12V, 2x KL, blauw	2RL 007 900-651

Onderdelen

Glaskap oranje links		9EL 861 912-001
Glaskap oranje rechts		9EL 861 913-001
Glaskap blauw links		9EL 861 912-021
Glaskap blauw rechts		9EL 861 913-021
Motor		9MN 860 677-021
Reflector (oranje uit.v)		9DX 861 872-001
Reflector (blauwe uitv.)		9DX 861 976-001
H1-gloeilamp		
12 V-55 W		8HG 002 089-131
24 V-70 W		8HG 002 089-251

6.0 Accessoires

Onderlegrubber

De 4 verschillende onderlegrubbers zijn aan de OWS uitvoeringen aangepast. Het materiaal is milieu vriendelijk en weerbestendig.

Het onderlegrubber zorgt voor een krasvrije montage en vangt trillingen op. Door het onderlegrubber wordt de OWS èèn geheel met het voertuig.

OWS 540
Standaard onderlegrubber
(wordt meegeleverd)

Lengte: 320 mm
Best.nr.
9GD 862 086-001

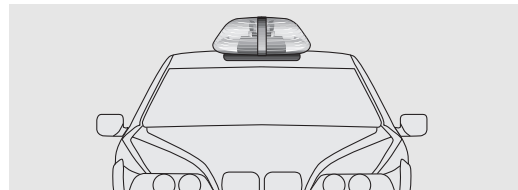
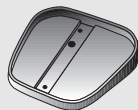

OWS 1000

Lengte: 751 mm
Best.nr.
9GD 862 080-001

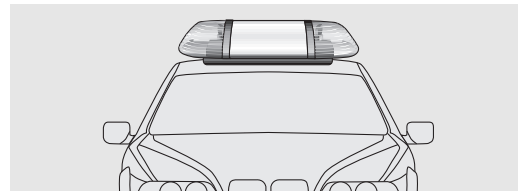
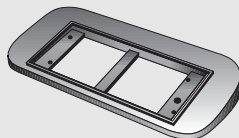

OWS 1400

Lengte: 1151 mm
Best.nr.
9GD 862 081-001

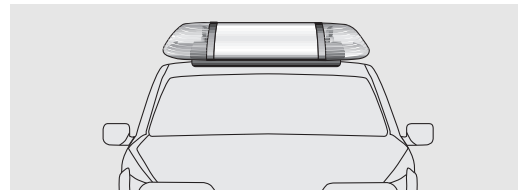
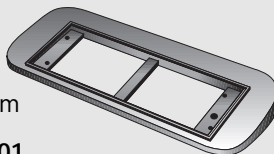

OWS 1600

Lengte: 1351 mm
Best.nr.
9GD 862 085-001

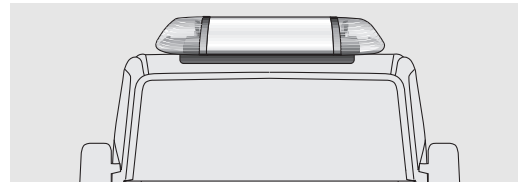
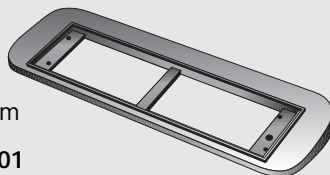

Accessoires

Set dragers

Het set dragers bestaat uit twee delen en wordt onder de bestaande houder bevestigd.

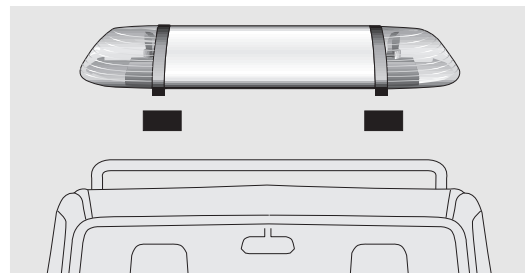
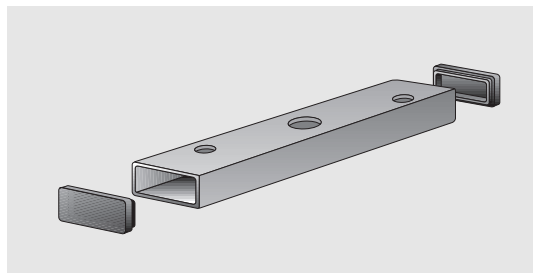

Set houders voor directe montage

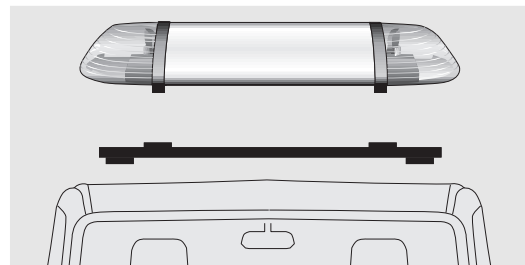
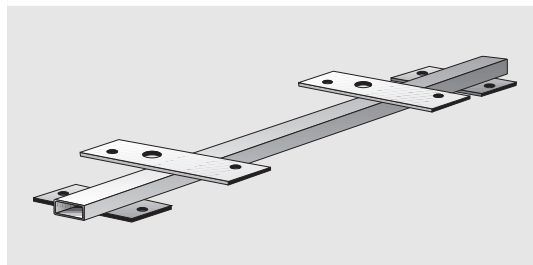

Bevestigingssysteem 9XD 857 445-001

Spanbeugel 9XD 857 421-801

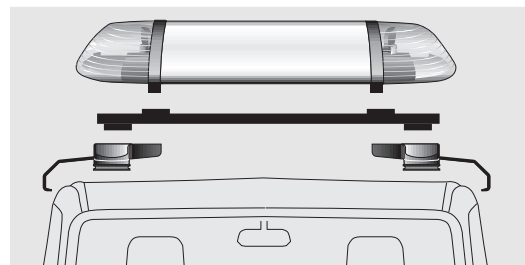
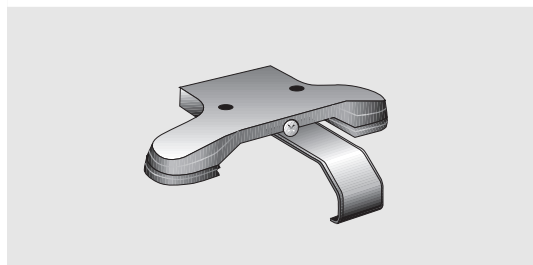

Fittingplaat (incl. gloeilampen)

Uitrusting: OWS 1000 (1 x)
OWS 1400 (2 x)
OWS 1600 (2 x)

Best.nr.
9FT 861 790-001 12 V
9FT 861 790-011 24 V

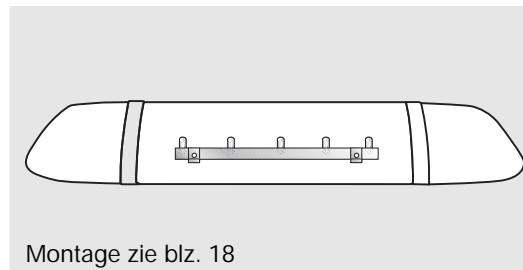
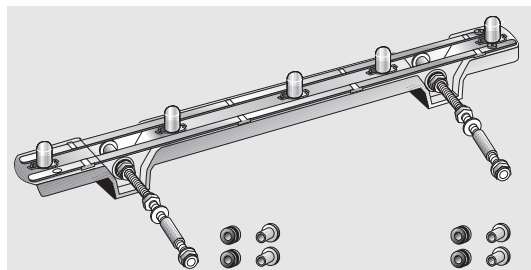

Gloeilampen

Gloeilampen voor
beletteringszone
5 x 5 W / 10 x 5 W

Best.nr.
9GP 003 594-131 12 V
9GP 003 594-251 24 V

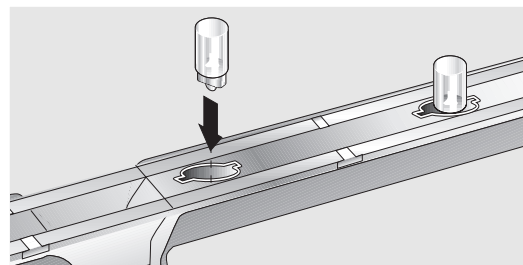
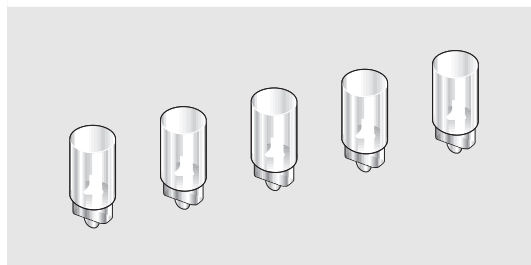

Schakelaar met controlelamp

1 maal voor de belettering
1 maal voor de zwaailampen

Best.nr.
6ED 004 778-011

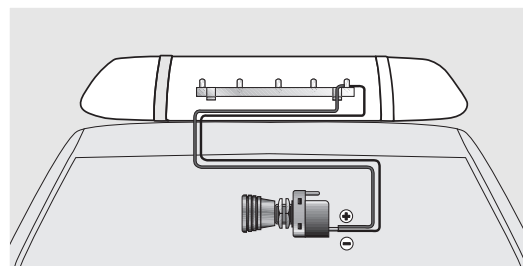
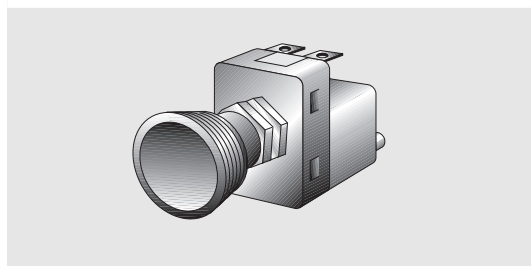

Accessoires

Montage fittingplaat voor de
belettering.

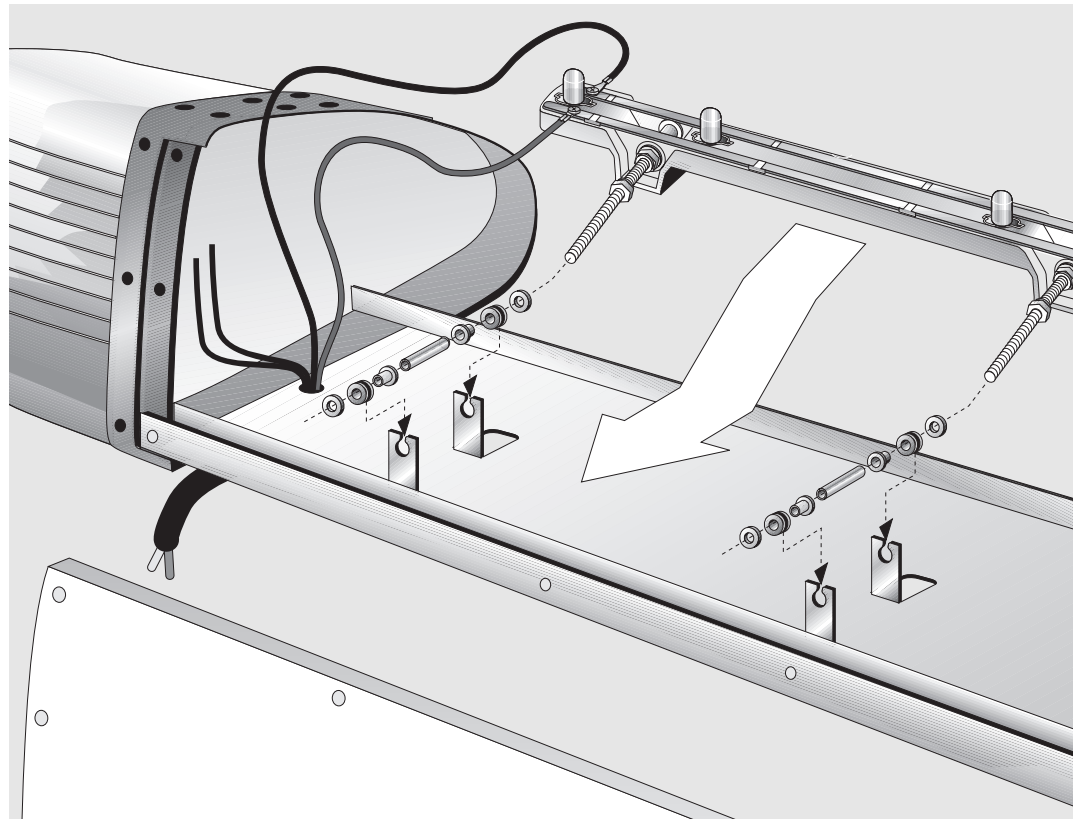

7.0 Foutanalyse

Zwaailampen

Zwaailampen	Mogelijke oorzaak
Èen of beide zwaailampen geven geen licht terwijl de reflector draait.	Testen, of de gloeilamp kapot is.
Reflector draait niet, gloeilampen branden.	Testen, of de motor, of de aandrijving defect is.
Gloeilampen en reflectoren functioneren niet.	Testen, of op in de zekeringskast ingangs- resp. uitgangsspanning staat.
	Ja = Testen, of in de OWS aan klem 72 spanning staat.
	Nee = Kabel naar klem 30 in de zekeringskast is defect, of de zekering is defect.
	Testen, of de massakabel naar de zwaailampen functioneert.

Verlichting van de belettering

Storing	Mogelijke oorzaak
Belettering niet volledig verlicht.	Testen, of gloeilamp of zekering defect is.

Heeft u nog vragen dan geeft
Sluyter B.V. u graag en snel
antwoord.

Telefoon
030- 6095611

Sluyter B.V.
Celsiusbaan 2
Postbus 1398
3430 BJ Nieuwegein
(NL)

Sistema óptico de advertencia OWS Hella

Manual técnico

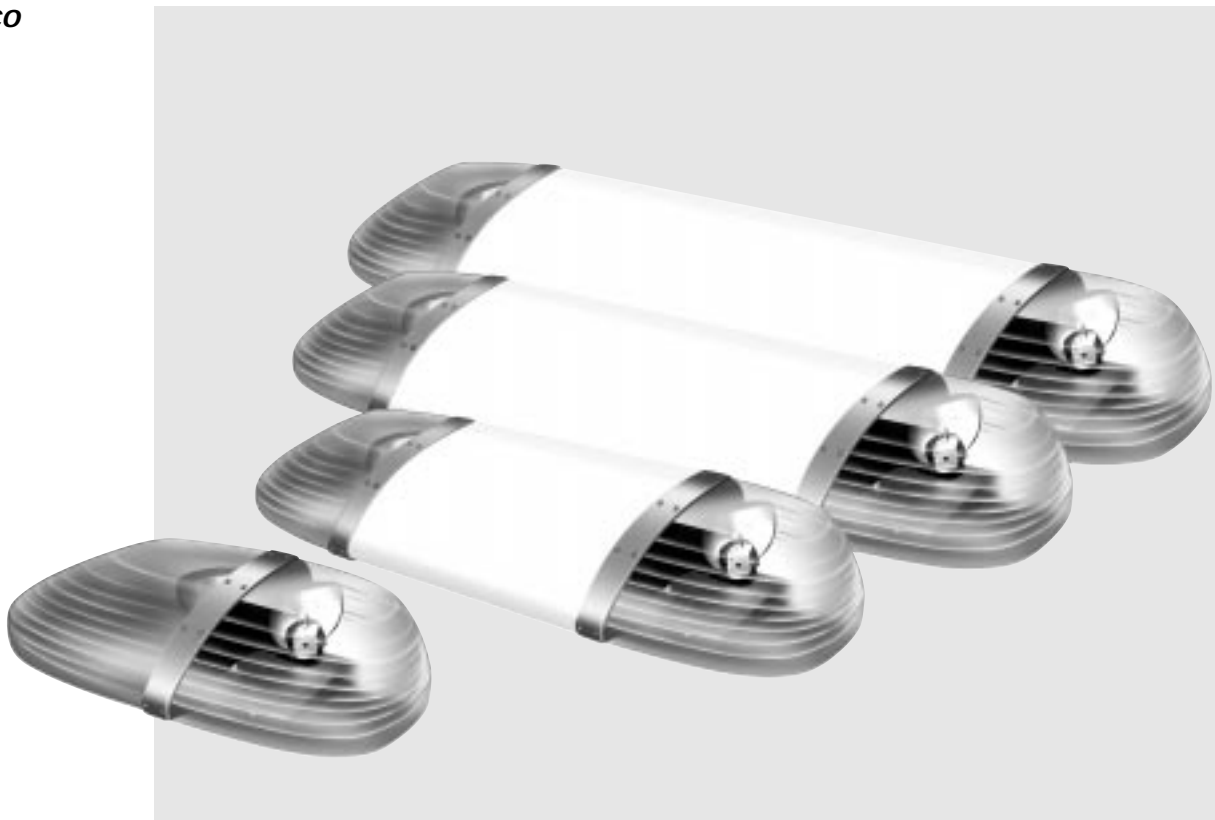

Antes de iniciar el montaje lea estas instrucciones atentamente y siga exactamente las operaciones de montaje por orden sucesivo.

Un montaje inadecuado puede perjudicar la seguridad funcional de su vehículo.

Manual técnico

Sistema óptico de advertencia OWS Hella

Indice

	Página
1.0 Información general	104
2.0 Montaje	106
3.0 Conexión eléctrica	112
4.0 Datos técnicos	113
5.0 Versiones / Repuestos	114
6.0 Accesorios	115
7.0 Búsqueda de fallos	119

1.0 Información general

Sistema y funciones

El Hella OWS es un sistema compacto para vehículos municipales, servicios de asistencia en carretera, vehículos de longitud o

anchura extraordinaria con luces rotativas de color ámbar y un panel iluminable por dentro para rotular individualmente.

El Hella OWS consta de los siguientes componentes:

- Luces rotativas, ámbar (dos luces rotativas en 360° con reflector giratorio y lámparas halógenas H1).
- Panel para reequipar con rótulo iluminable por dentro (cinco y/o 10 lámparas conectadas en serie)*

*) La rotulación iluminable por dentro no está autorizada en el ámbito de homologación del StVZO así como tampoco en Austria y en Suiza

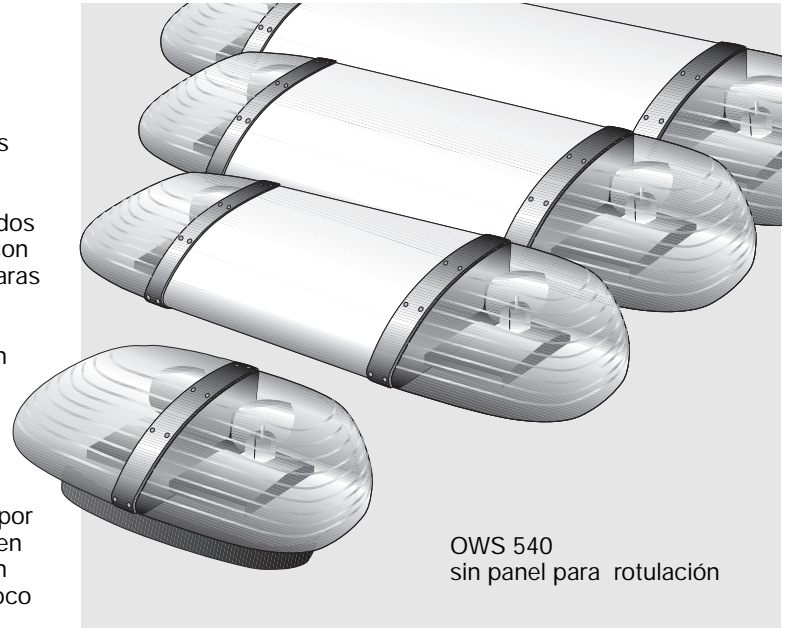

OWS 540
sin panel para rotulación

Para múltiples aplicaciones

Tan diversas como son las posibilidades de aplicación del OWS, también pueden ser los rótulos a utilizar.

Los paneles de gran superficie permiten múltiples posibilidades de rotulación.

Los paneles anterior y posterior pueden imprimirse fácilmente con la rotulación elegida

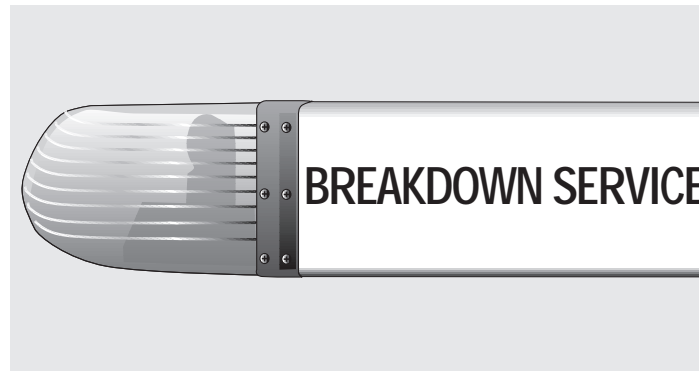

Posibilidad de rotulación por ambos lados

Un vehículo especial bien señalado atrae mejor la atención de los demás usuarios de la vía.

La rotulación se puede leer claramente, incluso bajo adversas condiciones climatológicas, gracias a la claridad que proporcionan las dos luces rotativas.

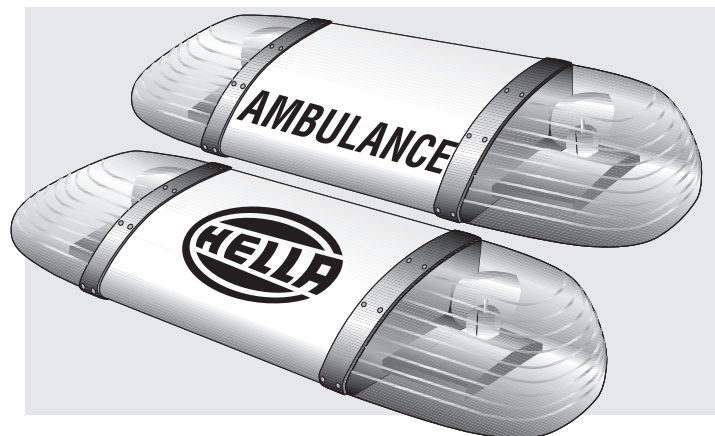

2.0 Montaje

Antes de iniciar el montaje hay que aclarar con el fabricante del vehículo si es necesario reforzar el techo del vehículo.

Señalar el punto de montaje sobre una superficie plana en el techo del vehículo y preparar la fijación según la clase de montaje

¡Atención!

Después de cada montaje y antes de iniciar un viaje se ha de controlar el buen acople de la instalación y el asiento fijo de los estribos de fijación. Antes de perforar los agujeros prestar atención que no sean dañadas las partes del vehículo que se encuentran debajo. Se recomienda sellar con anticorrosivo los agujeros perforados en metal. Después del montaje obtener los pasos de cable con un pegamento obturador.

2.1 Montaje fijo

Marcar el contorno del OWS alineado sobre el techo del vehículo conforme se indica en el dibujo acotado. Prestar atención a la curvatura del techo.

Retirar el revestimiento del techo en el interior del vehículo.

Perforar los agujeros conforme se indica en el dibujo acotado.

Conducir el cable preparado a través del paso de cables.

La superficie de apoyo sobre el techo del vehículo ha de estar bien limpia y seca.

Plantilla para taladrar
OWS 540

Dirección de marcha

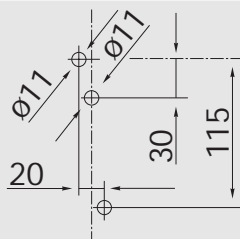

Croquis de taladros para todos los tipos

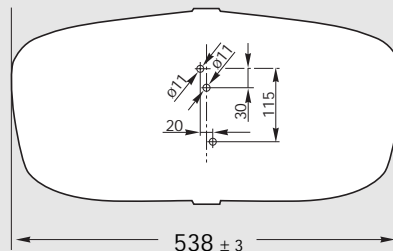

Plantilla para taladrar
OWS 1000

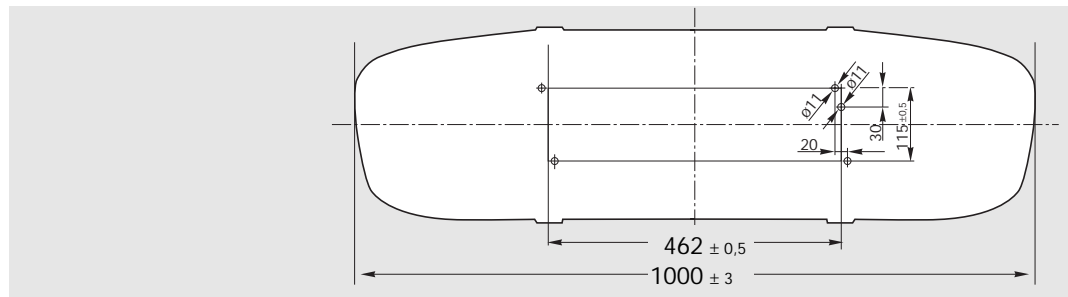

Plantilla para taladrar
OWS 1400

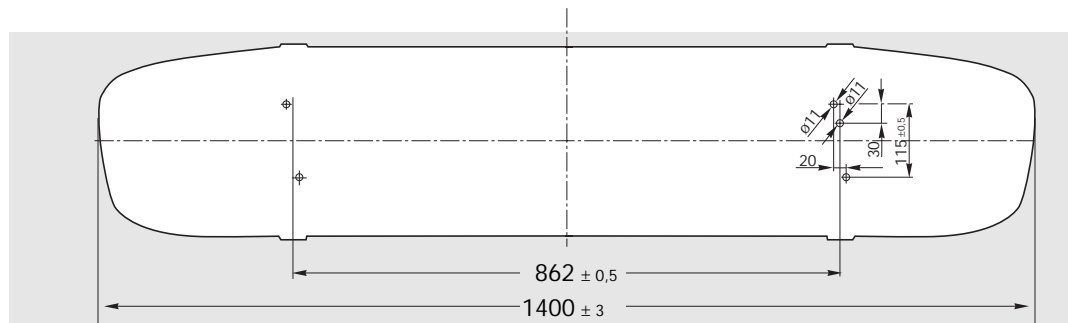

Plantilla para taladrar
OWS 1600

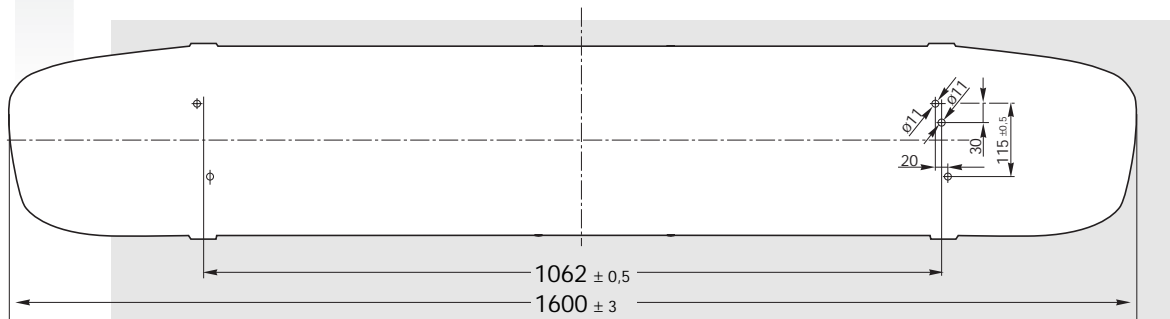

Montaje

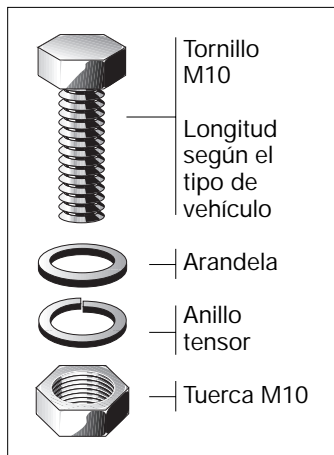

El material de fijación no forma parte del suministro

Tornillos de fijación M 10

Par de apriete máx. 4 Nm

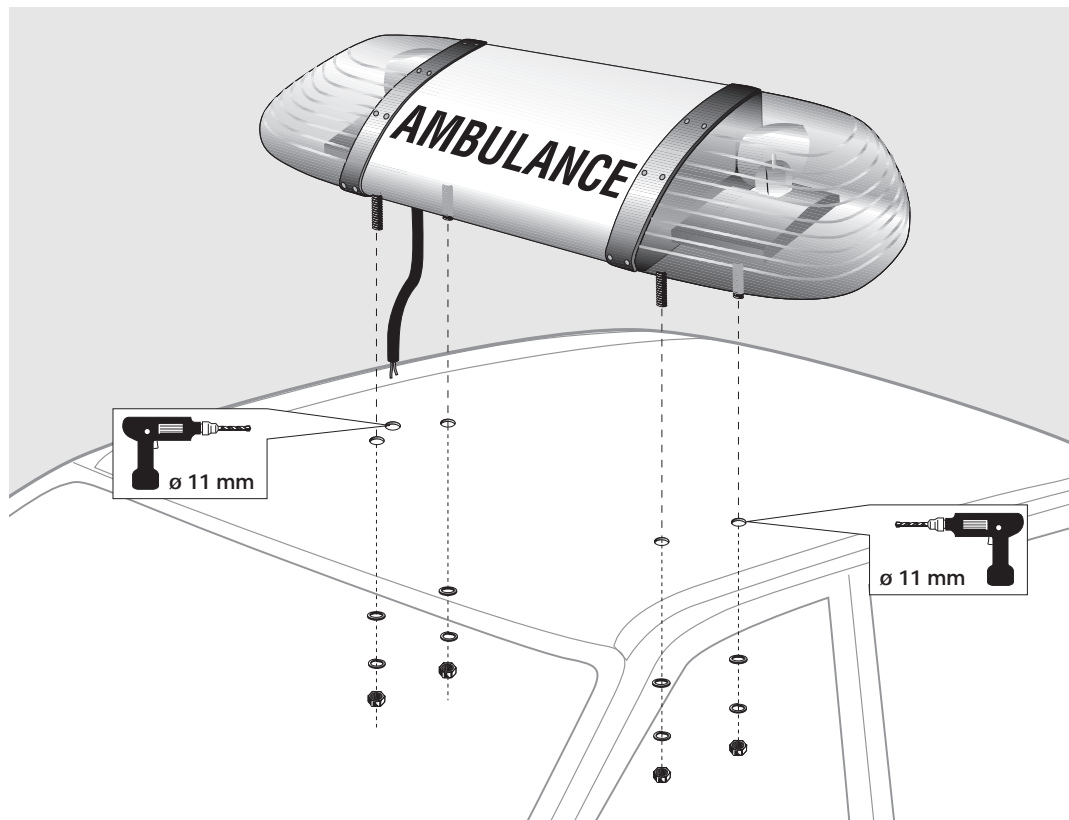

2.1.1 Montaje fijo con las juntas de goma adjuntas

(no para la versión OWS 540)

Introducir los tornillos de fijación M10 en las bridas de sujeción del refuerzo-portador a derecha e izquierda.

Colocar a presión la junta de goma en la base de montaje.

Conducir el cable de conexión a través del paso de cables. Introducir los tornillos de fijación en los agujeros taladrados previamente en el techo del vehículo. Colocar encima el aparato y atornillarlo a fondo.

Tras haber practicado la fijación, controlar si las luces rotativas quedan en posición vertical.

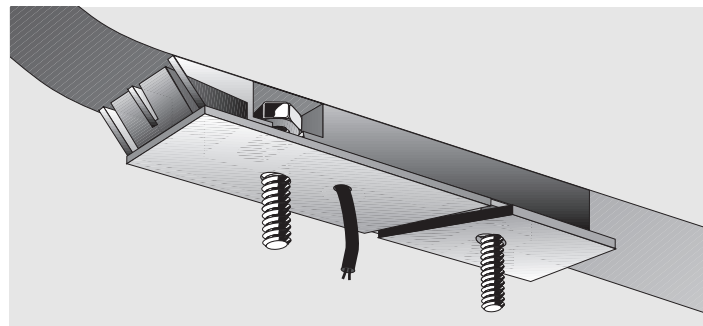
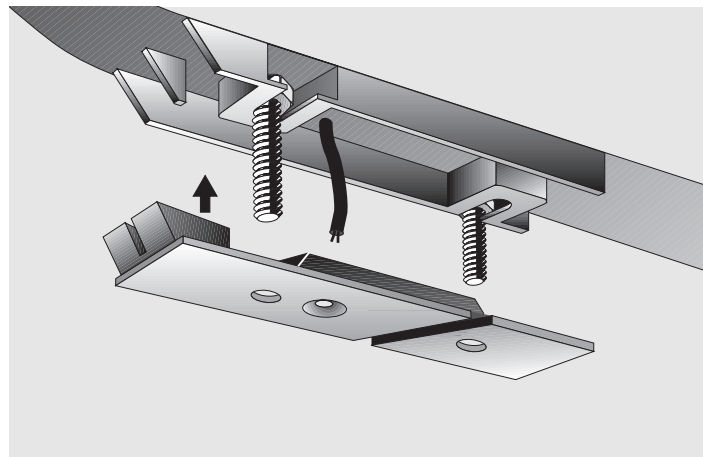

2.1.2 Montaje fijo con base de goma grande

Las juntas de goma adjuntas no se necesitan.

Introducir los tornillos de fijación M 10 en las bridas de sujeción del soporte a derecha e izquierda.

Aplicar la base de goma a la parte inferior del OWS.

Colocar el aparato sobre el techo del vehículo. Conducir el cable a través del paso de cables e introducir los tornillos en los agujeros taladrados previamente .

A continuación atornillar a fondo el OWS.

Tras haber practicado la fijación, controlar si las luces rotativas quedan en posición vertical. La corrección de nivelación es posible atornillando más o menos fuertemente los tornillos de fijación..

Asegurar una visibilidad de las luces en 360°.



2.2 Montaje tensor

(véase accesorios en el punto 6.0)

Como alternativa al montaje fijo existe la posibilidad de un montaje tensor. Para ello sólo se taladra el agujero para el paso del cable. Colocar a presión las juntas de goma adjuntas en la base de montaje del OWS.

Atornillar el sistema de fijación 9DX 857 445-001 debajo del soporte.

Atornillar ahora este sistema debajo del OWS con junta de goma.

Los estribos de tensión deben adaptarse al tipo de vehículo respectivo.

2.3 Montaje magnético

Con el OWS 540 con pie magnético, es posible cambiar con rapidez toda la unidad de luz de señalización.

¡La unidad de luz de señalización sólo puede utilizarse sobre techos de acero!

El lugar de emplazamiento deberá estar libre de suciedad, agua, hielo, nieve, hojas, etc.

¡Atención! Velocidad máxima admisible: 120km/h.

La conexión eléctrica (conducción de cable) hacia la caja de enchufe DIN puede realizarse a través de la ventanilla abierta, teniendo a este respecto en cuenta que el cable de conexión no sea pillado ni aplastado.

¡Si no se utiliza la unidad de luz de señalización, guardarla en el vehículo de modo que no pueda originar un impedimento para el conductor o el acompañante!

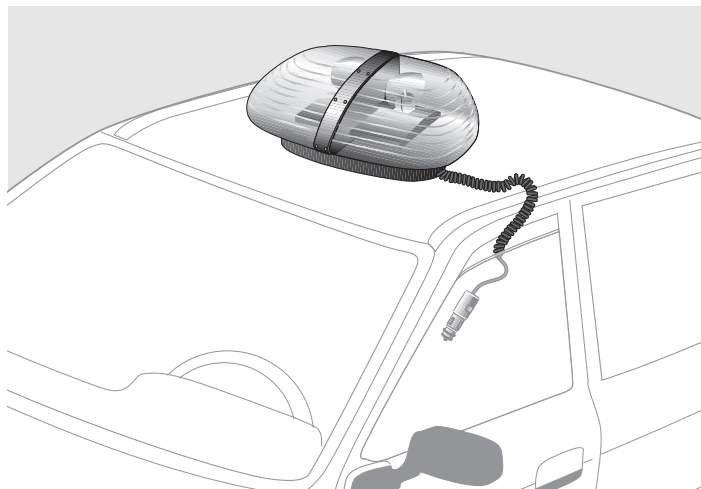
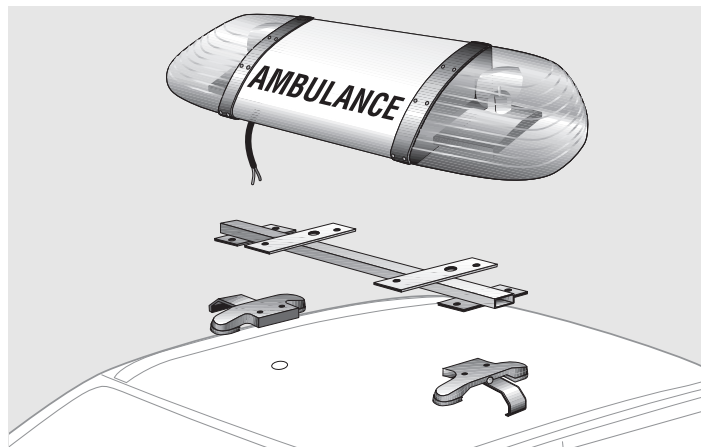

3.0 Conexión eléctrica

Antes de iniciar el montaje, desembornar la batería del vehículo.

Los cables permiten conducirse de la mejor forma hacia delante, pasándolos por encima de los travesaños laterales. Al respecto debe evitarse un doblado extremo de los cables en ángulos y cantos.

Luces rotativas:
 12V = 2 x 55 W;
 24 V = 2 x 70 W
 Colocar el cable en el vehículo, cortarlo a la longitud requerida y conectarlo a través de conmutador.

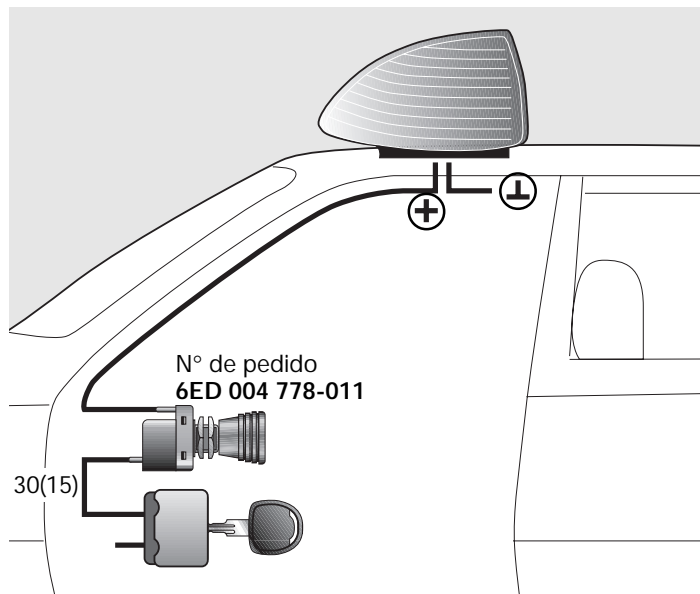

- Cable positivo = blanco (proteger por posible, conmutador con lámpara de control (ver recambios))
- Cable negativo = azul
- Reequipamiento p.ej. Iluminación interior: negro, marrón

4.0 Datos técnicos

Datos técnicos del OWS Hella

Datos técnicos generales	
Anchura	~ 300 mm
Altura (sin base)	~ 180 mm
Peso:	
OWS 540	~ 3.0 kg
OWS 1000	~ 5.5 kg
OWS 1400	~ 7.0 kg
OWS 1600	~ 8.0 kg
Clase de protección: IP 5K4K9K (lavado a alta presión)	
Temperatura de servicio:	- 40 °C hasta + 60 °C
Temperatura de almacenamiento:	- 40 °C hasta + 85 °C
Tensión de servicio:	(U _N)12 V y 24 V
Gama de tensión de servicio	
12 V	10...15.5 V
24 V	20...31.0 V
Absorción de corriente	
Luces rotativas	2 x 4,7 A (12 V) 2 x 2,7 A (24 V)
Dispersor iluminado	~4 A (12 V) ~2 A (24 V)

Datos técnicos para sistemas ópticos

Accionamiento: por tornillo sin fin

Velocidad nominal: 160 r.p.m.

Reflector parabólico lacado en color plata con lámpara fija (versión ámbar)

Reflector parabólico metalizado a alto brillo con lámparas integradas (versión azul)

Lámpara H1:
halógena 12V / 55 W; 24 V / 70W

Dispersor (material) PMMA blanco lechoso

Dispersor (material) ámbar = PC
azul = PMMA

Antiparasitaje según VDE 879 parte 3

Grado de antiparasitaje 5,

Antiparasitaje contra interferencias cercanas para vehículos

Homologación: azul B1 E1 00817
ámbar A1 E1 00774
CE e1 021309

5.0 Versiones / Repuestos

Sistema completo

OWS tipo	Ejecución	N° de pedido
OWS-540	12V, 2 luces rotativas, ámbar	2RL 007 900-501
OWS-540	12V, 2 luces rotativas, azules	2RL 007 900-551
OWS-540	24V, 2 luces rotativas, ámbar	2RL 007 900-511
OWS-540	24V, 2 luces rotativas, azules	2RL 007 900-561
OWS-540 Imán	12V, 2 luces rotativas, ámbar	2RL 007 900-521
OWS-540 Imán	12V, 2 luces rotativas, azules	2RL 007 900-571
OWS-1000	12V, 2 luces rotativas, ámbar	2RL 007 900-001
OWS-1000	12V, 2 luces rotativas, azules	2RL 007 900-151
OWS-1400	12V, 2 luces rotativas, ámbar	2RL 007 900-201
OWS-1400	24V, 2 luces rotativas, ámbar	2RL 007 900-211
OWS-1400	12V, 2 luces rotativas, azules	2RL 007 900-251
OWS-1600	12V, 2 luces rotativas, ámbar	2RL 007 900-601
OWS-1600	24V, 2 luces rotativas, ámbar	2RL 007 900-611
OWS-1600	12V, 2 luces rotativas, azules	2RL 007 900-651
Repuestos		
Dispensor ámbar, izq.		9EL 861 912-001
Dispensor ámbar, der.		9EL 861 913-001
Dispensor azul, izq.		9EL 861 912-021
Dispensor azul, der.		9EL 861 913-021
Motor		9MN 860 677-021
Reflector (ámbar)		9DX 861 872-001
Reflector (azul)		9DX 861 976-001
Lámpara halógena		
12 V-55 W		8HG 002 089-131
24 V-70 W		8HG 002 089-251

6.0 Accesorios

Base de goma

Las bases de goma fabricadas de material favorable al ambiente y resistente a la intemperie han sido adaptadas a los cuatro modelos del OWS.

OWS 540

Base de goma estándar

Longitud: 320 mm
N° de pedido
9GD 862 086-001

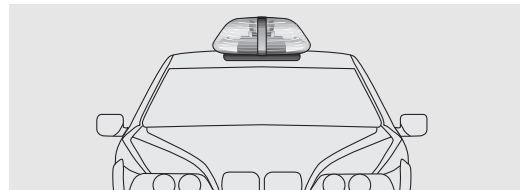
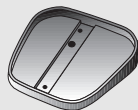

OWS 1000

Longitud: 751 mm
N° de pedido
9GD 862 080-001

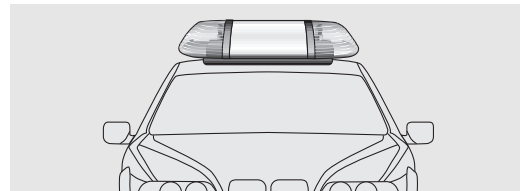
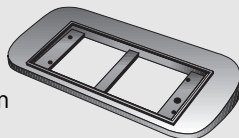

OWS 1400

Longitud: 1151 mm
N° de pedido
9GD 862 081-001

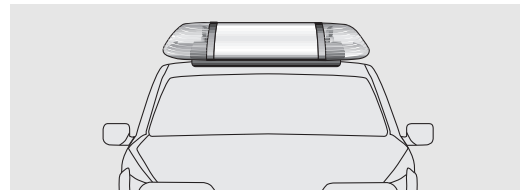
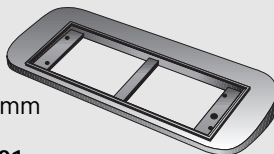

OWS 1600

Longitud: 1351 mm
N° de pedido
9GD 862 085-001

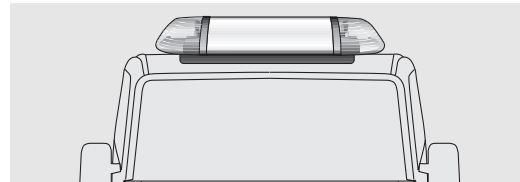
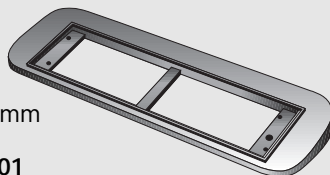

Accesorios

Refuerzo-portador

El refuerzo-portador consta de dos piezas y ha de soldarse directamente sobre un soporte ya existente.

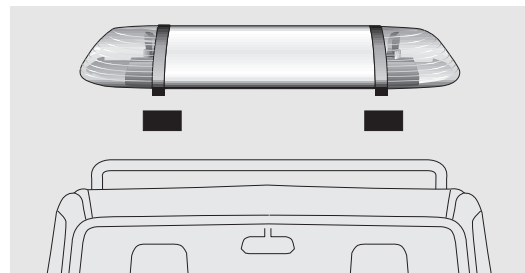
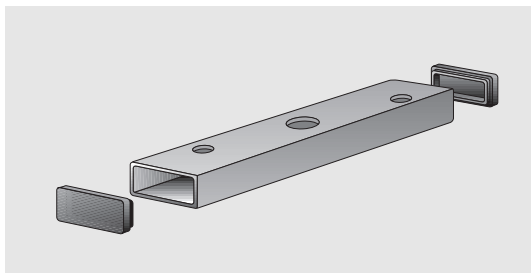

Soporte para montaje directo

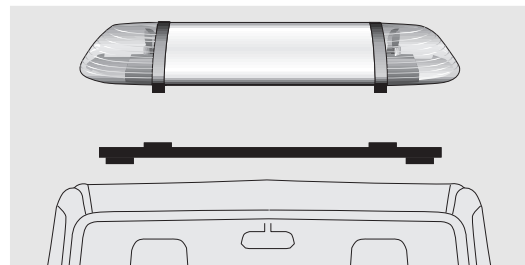
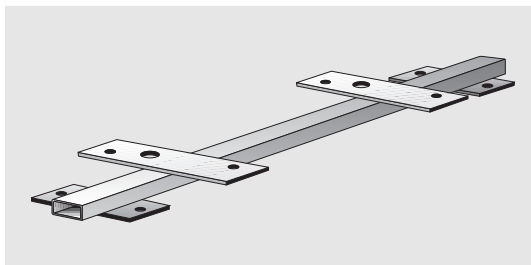

Sistema de fijación 9XD 857 445-001

Estribo tensor 9XD 857 421-801

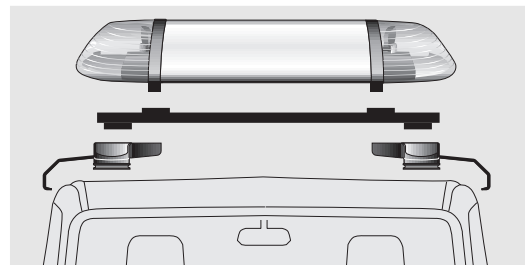
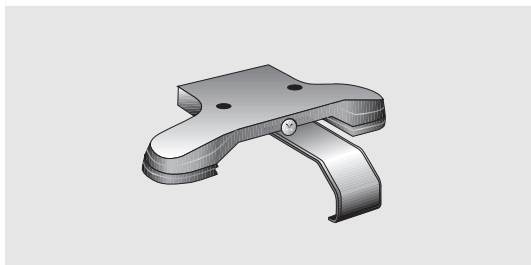

Portalámparas (con lámparas)

Equipamiento: OWS 1000 (1 x)
OWS 1400 (2 x)
OWS 1600 (2 x)

Nº de pedido

9FT 861 790-001 12 V

9FT 861 790-011 24 V

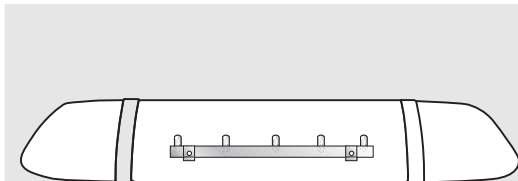
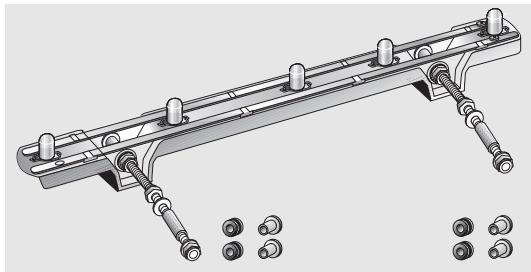

Montaje véase página 18

Lámparas (repuestos)

Iluminación del dispensador
5x5 W ó 10x5 W
reequipable.

Nº de pedido

9GP 003 594-131 12 V

9GP 003 594-251 24 V

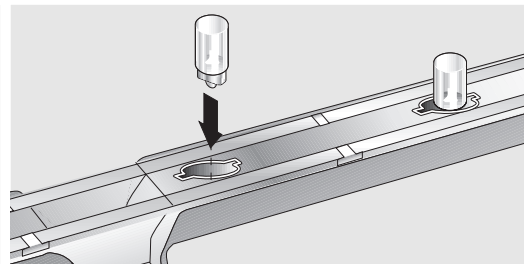
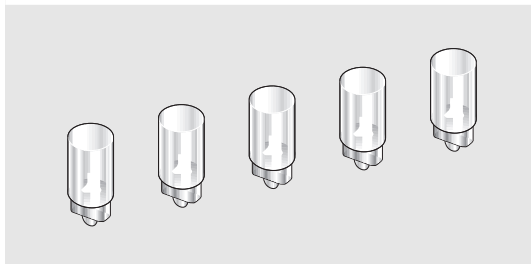

Conmutador con lámpara de control

1 respectivamente
para iluminación interior

1 respectivamente
para la función de luces
rotativas

Nº de pedido

6ED 004 778-011

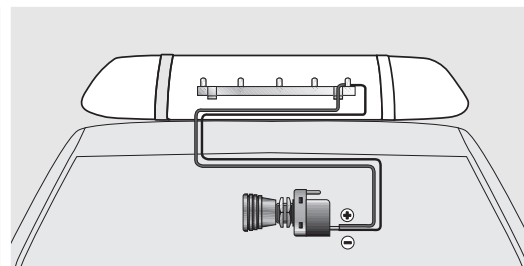
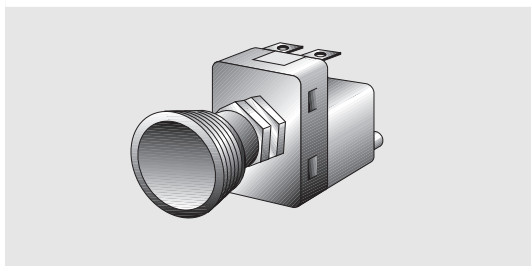

Accesorios

Montaje de la iluminación del panel

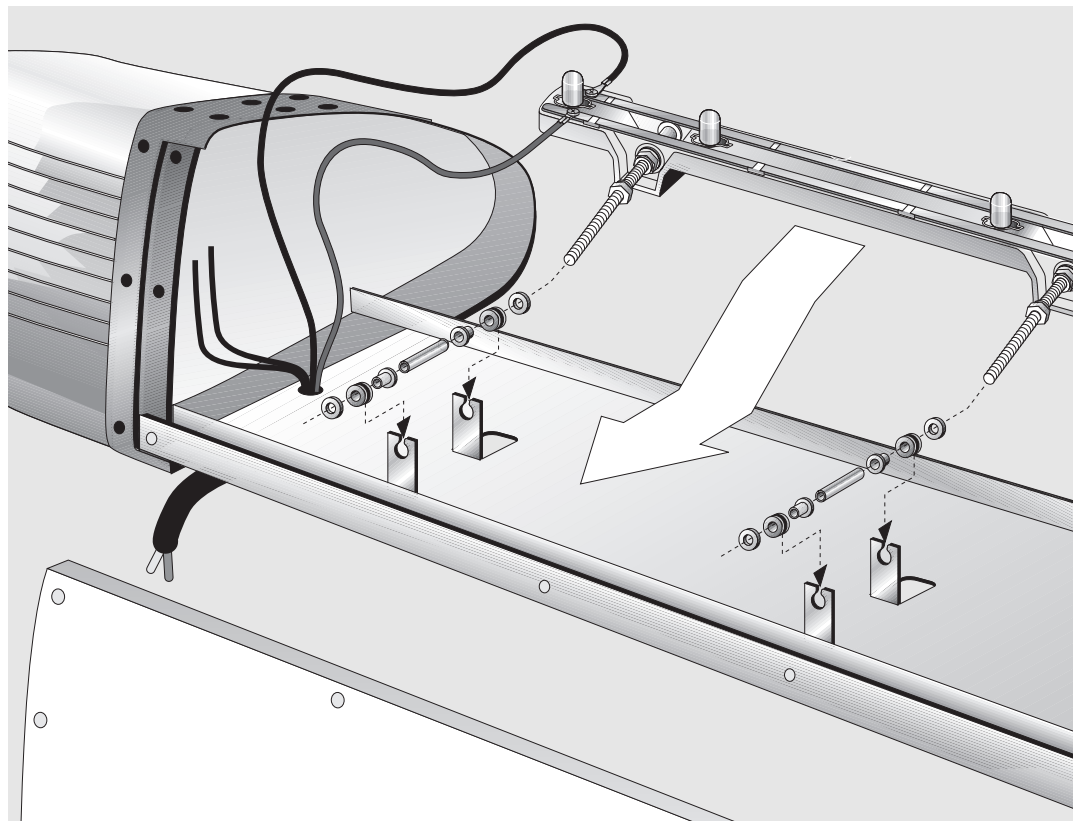

7.0 Búsqueda de fallos

Luz rotativa

Luz rotativa	Causa probable
Una o ambas luces rotativas no iluminan al girar el reflector	Controlar si la lámpara se ha fundido
El reflector no gira pero las lámparas funcionan.	Controlar el estado del accionamiento y del motor.
Ambas luces rotativas no iluminan y los reflectores no giran	Controlar si hay tensión de a bordo a la entrada o salida de la caja de fusibles
	si = Controlar si hay tensión de a bordo en el borne 72 del aparato (motor)
	no = El cable 30 que conduce a la caja de fusibles o el fusible tienen defecto.
	Controlar si el cable de masa tiene paso a las luces rotativas.

Iluminación del panel

Fallo	Causa probable
El rótulo no se ilumina por completo.	Controlar si la lámpara o el fusible están defectuosos

Si aún tiene preguntas o
problemas de montaje
póngase en contacto con el
servicio postventa de Hella a
través de su concesionario

Ⓓ **(0180) 5 25 00 02**

Hella KG Hueck & Co.
Rixbecker Straße 75

D-59552 Lippstadt

Sistema di segnalazione ottica Hella OWS

Manuale tecnico

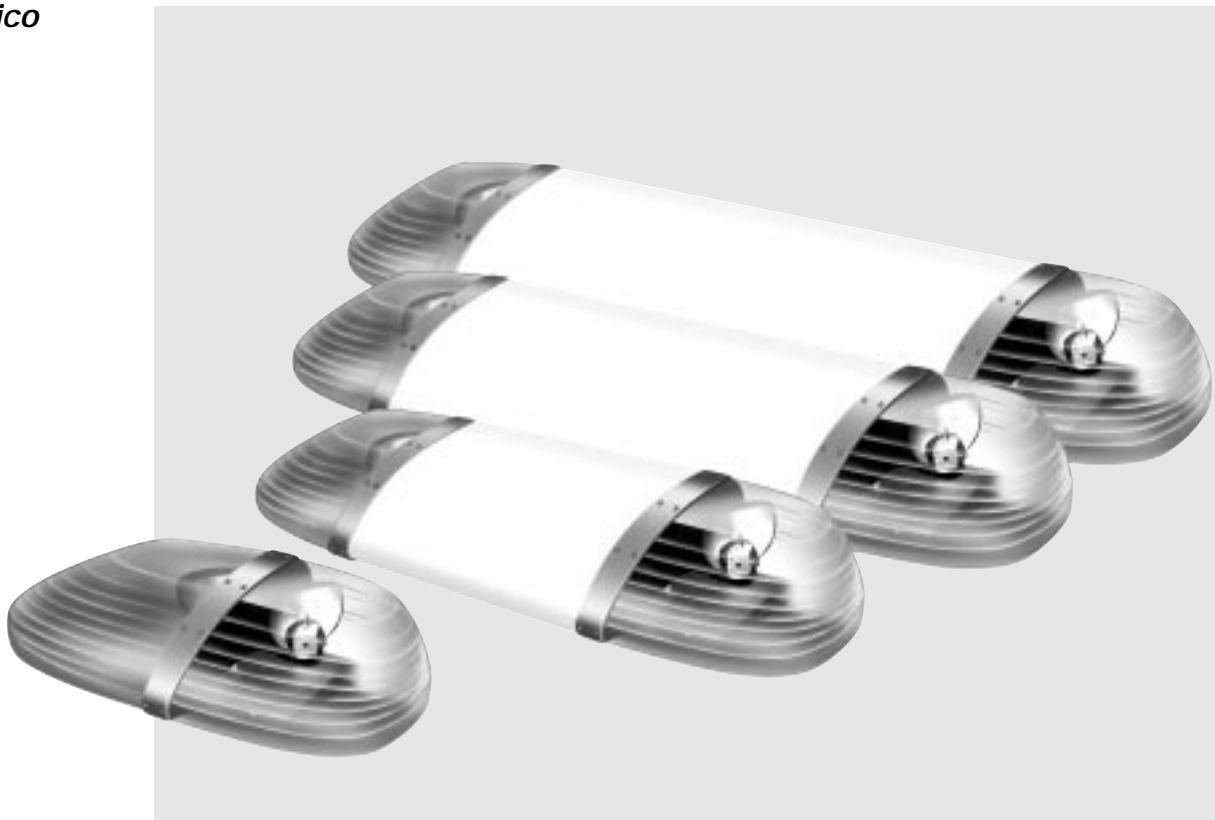

Prima di iniziare il montaggio leggere attentamente queste istruzioni di installazione ed uso facendo attenzione all' esatta successione delle operazioni da eseguire.

Un montaggio non conforme potrebbe compromettere il funzionamento e la sicurezza stessa dell' automezzo.

Manuale tecnico

Sistema di segnalazione ottica Hella OWS

Indice

	Pagina
1.0 <i>Informazioni generali</i>	124
2.0 <i>Montaggio</i>	126
3.0 <i>Collegamento elettrico</i>	132
4.0 <i>Dati tecnici</i>	133
5.0 <i>Versioni disponibili / Ricambi</i>	134
6.0 <i>Accessori</i>	135
7.0 <i>Ricerca eventuali difetti</i>	139

1.0 Informazioni generali

Sistema e funzioni

OWS Hella è un sistema compatto di segnalazione ottica per automezzi di

pubblica utilità come carri per soccorso stradale, manutenzione strade, trasporti eccezionali.

Si compone di proiettori girevoli gialli e di una superficie per eventuali scritte personalizzate con unità di comando dall' interno.

Le parti del sistema Hella OWS:

- Proiettori girevoli gialli (due dispositivi con parabole rotanti e lampadine alogene H1)
- Superficie bianco latte per scritte personalizzate (5 oppure 10 lampadine inserite in parallelo) *

*) L' illuminazione della scritta con comando dall' interno è consentita solo nei paesi dove le norme lo permettono.

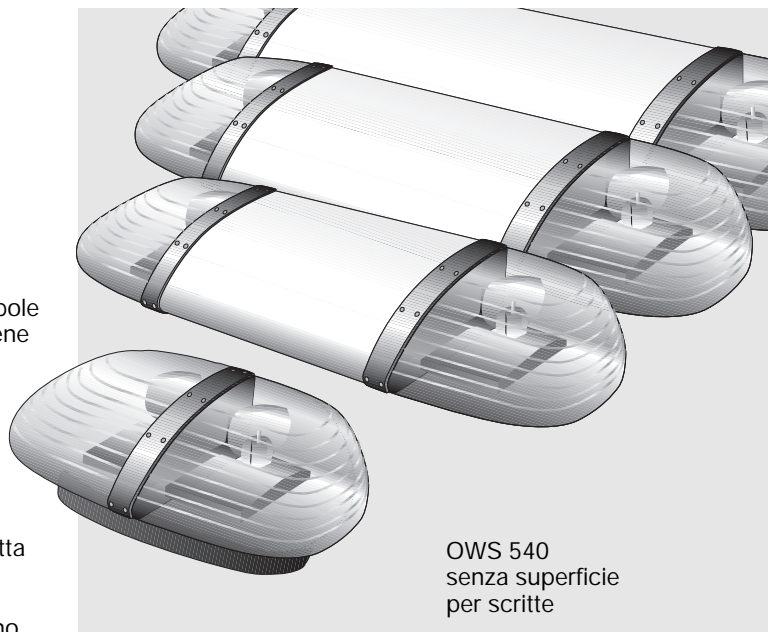

OWS 540
senza superficie
per scritte

Versatile negli impieghi

OWS Hella è altrettanto versatile negli impieghi che nelle possibilità delle scritte da inserire.

Le plastiche retroilluminate offrono un' ampia gamma di scritte personalizzate di varie grandezze.

Le due plastiche anteriore e posteriore ben si prestano a scopi sia di utilità pubblica che pubblicitari.



Possibilità di apporre le scritte su entrambi i lati.

Contrassegnando opportunamente il vostro automezzo potrete attirare meglio l' attenzione degli altri utenti del traffico.

Le scritte applicate restano sempre ben visibili anche in situazioni meteorologiche sfavorevoli perché sempre nel raggio di luce dei proiettori girevoli.

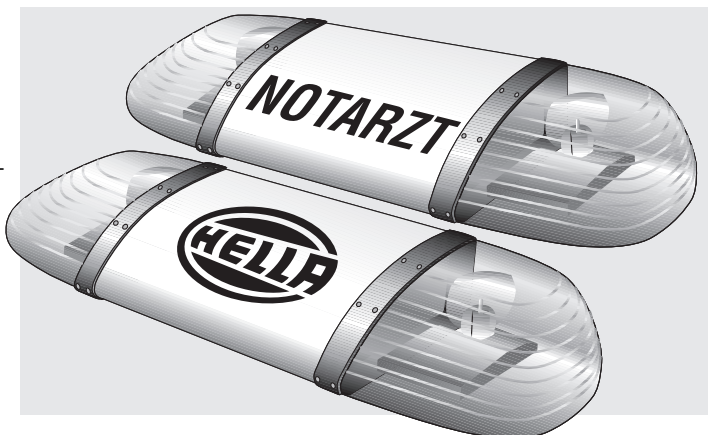
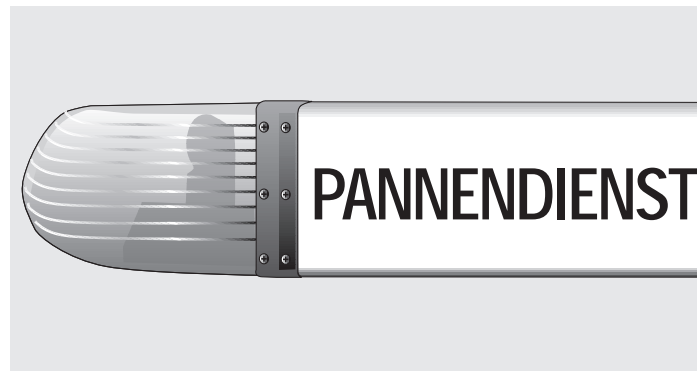

2.0 Montaggio

Prima di iniziare il montaggio verificare presso il costruttore del veicolo se è necessario un rinforzo del tetto.

Determinare il punto di applicazione, piano, sul tetto del veicolo e preparare il fissaggio secondo il procedimento prescelto.

Attenzione:

Dopo il montaggio e prima dell'uso su strada controllare accuratamente il fissaggio del dispositivo e le connessioni elettriche.

2.1 Montaggio fisso

Sulla base del disegno quotato segnare i contorni dell'OWS prescelto sul tetto del veicolo. Fare attenzione che la curvatura del tetto non sia superiore alla curva accettabile dalla barra stessa.

L'area del tetto interessata dovrà essere pulita e sgombra da ghiaccio e neve.

Rimuovere il rivestimento interno del tetto e praticare i fori necessari come da disegno quotato. Far passare i cavi di collegamento elettrico dall'apposita apertura.

Nel forare fare attenzione a non danneggiare eventuali componenti collocati nella parte sottostante. Raccomandiamo anche di proteggere i fori praticati con antiruggine e, dopo l'installazione, chiudere l'apertura passaggio cavi con un sigillante adeguato.

Dima di foratura
OWS 540

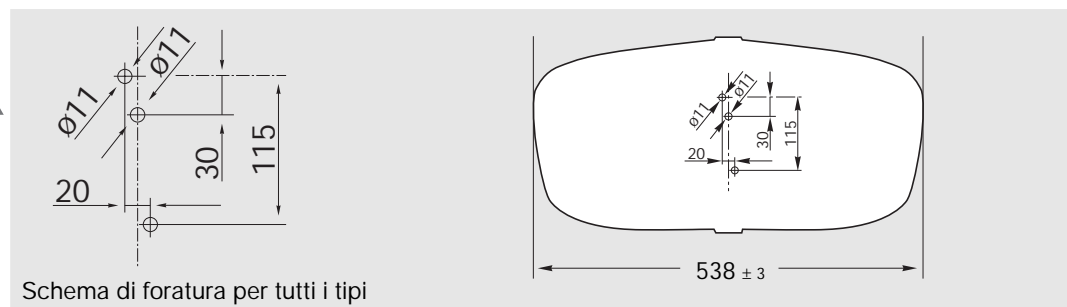

Dima di foratura
OWS 1000

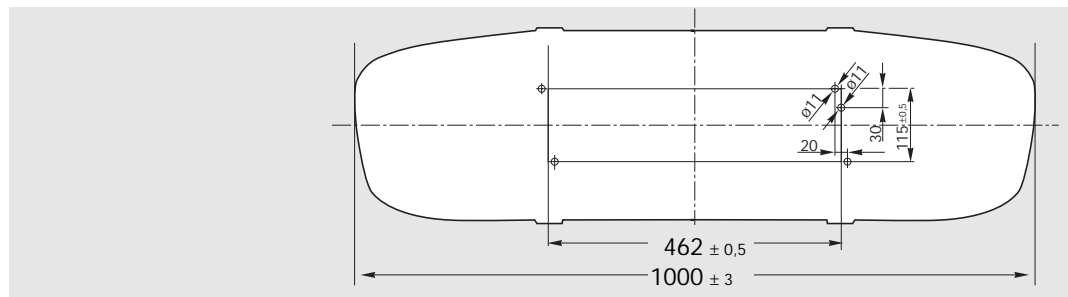

Dima di foratura
OWS 1400

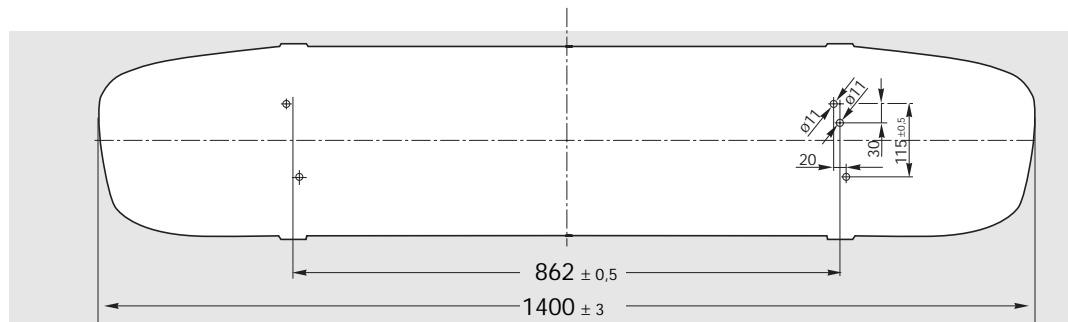

Dima di foratura
OWS 1600

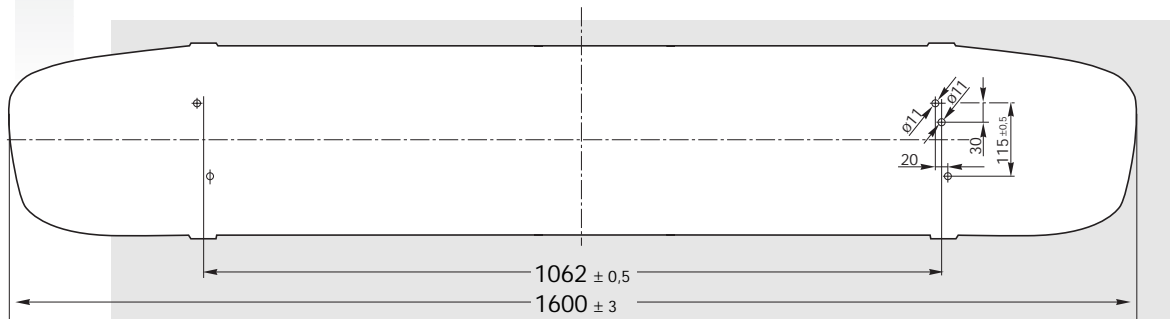

Montaggio

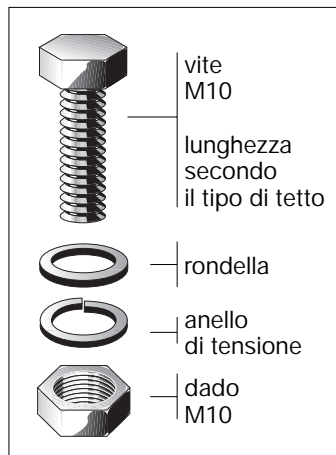

Il materiale di fissaggio non è in dotazione.

Viti di fissaggio
M10

Coppia di serraggio max.
4 Nm

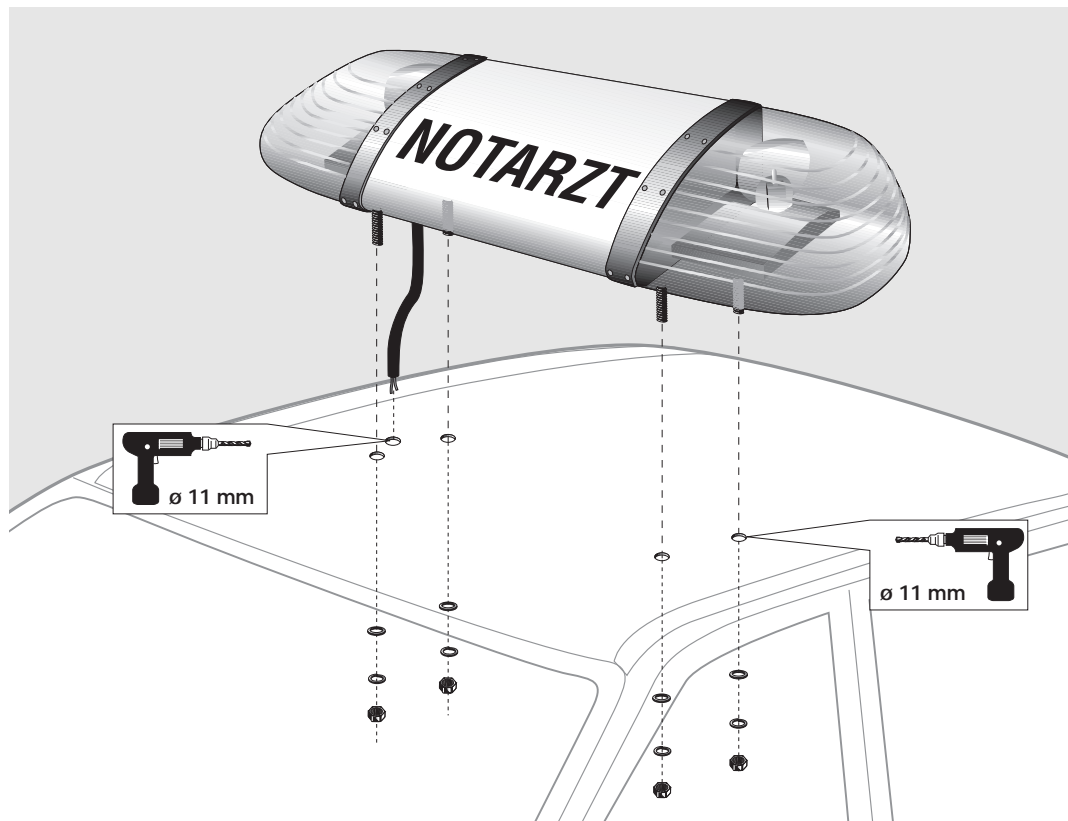

2.1.1.
Montaggio fisso
con guarnizioni
in gomma
in dotazione
(escluso OWS 540)

Inserire le viti di fissaggio M10 nell' apposita barretta, a destra e a sinistra, dell' elemento portante.

Inserire a pressione la guarnizione in gomma.

Far passare il cavo di collegamento dall' apposita apertura, infilare le viti nei fori predisposti del tetto, piazzare il dispositivo e serrare saldamente il tutto.

Dopo il fissaggio assicurarsi che i proiettori girevoli risultino verticali.

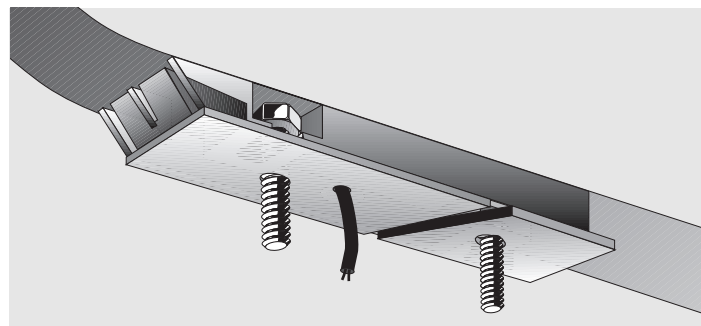
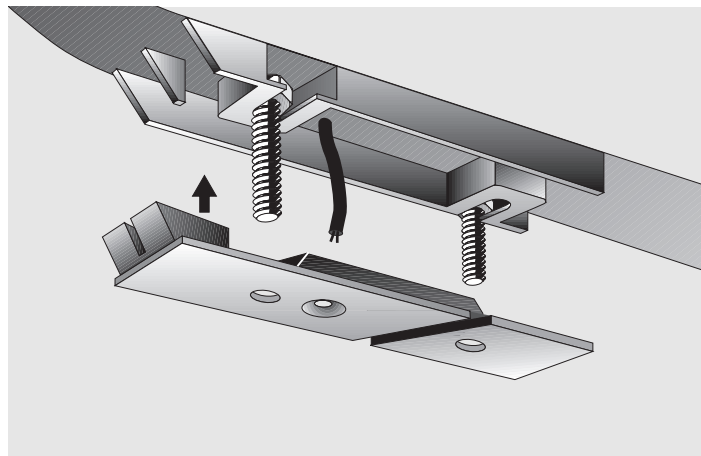

2.1.2. **Montaggio fisso con base in gomma grande**

Qui non vengono utilizzate le guarnizioni in dotazione.

Inserire le viti di fissaggio M10 nell' apposita barretta, a destra e a sinistra, dell' elemento portante.

Applicare la base in gomma al lato inferiore dell' OWS.

Piazzare il dispositivo sul tetto del veicolo, far passare il cavo di collegamento dall' apposita apertura e infilare le viti nei fori predisposti del tetto.

A questo punto fissare saldamente le viti di fissaggio.

Dopo il fissaggio assicurarsi che i proiettori girevoli risultino verticali. Eventuali piccole correzioni del livello sono possibili agendo opportunamente sul serraggio delle viti di fissaggio.

Controllare la visibilità del segnale su 360°!



2.2. Montaggio con tiranti

(vedi accessori al punto 6.0)

Il alternativa al montaggio fisso vi è anche la possibilità di un fissaggio con tiranti.

In questo caso occorrerà praticare sul tetto un solo foro per il passaggio dei cavi. Applicare a pressione le guarnizioni in gomma in dotazione nell' elemento di fissaggio dell' OWS.

Avvitare il sistema di fissaggio 9DX 857 445-001 sotto al supporto.

Questo sistema deve essere fissato sotto all' OWS con una guarnizione in gomma.

I tiranti devono essere adattati al tipo di automezzo.

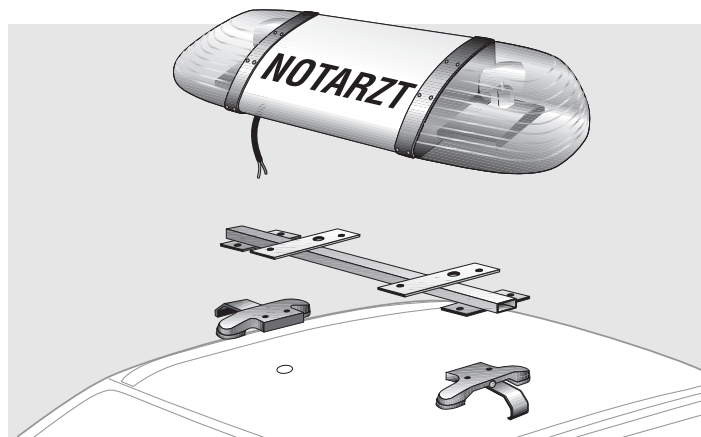

2.3. Montaggio magnetico

Con l' OWS 540 dotato di supporto magnetico è possibile trasferire rapidamente l' intero sistema di proiettori da una vettura all' altra.

Tale sistema di proiettori deve essere collocato unicamente su superfici metalliche.

Sulla superficie di applicazione non devono esserci sporcizia, acqua, ghiaccio, neve, carta, ecc.

Attenzione:
massima velocità ammessa:
120 km/h!

Il collegamento elettrico alla presa DIN dell' auto può essere effettuato con il finestrino aperto. Bisogna quindi fare attenzione che il cavo non venga schiacciato o piegato.

Se durante la marcia il sistema di proiettori non viene utilizzato, fare in modo che il cavo di alimentazione non disturbi il conducente e i passeggeri.

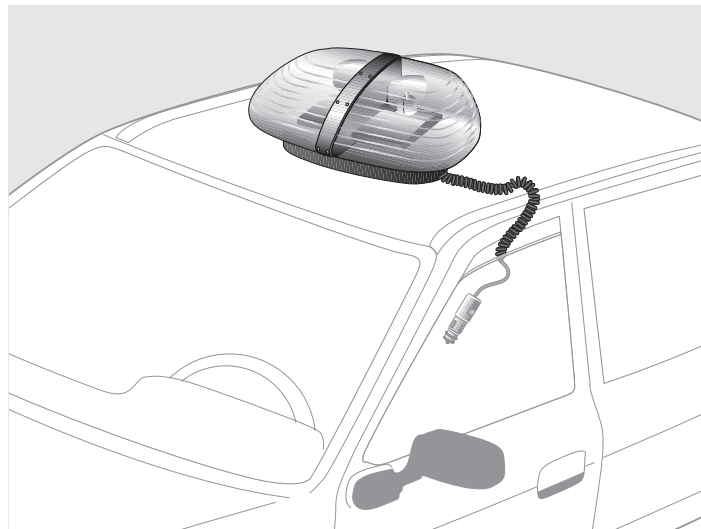

3.0 Collegamento elettrico

Prima di iniziare il montaggio scollegare la batteria del veicolo.

Il cavo va portato alla parte anteriore del veicolo facendolo passare preferibilmente nel cavo del montante laterale ed evitando piegature troppo pronunciate.

Proiettori girevoli:
 12 V = 2 x 55 W
 24 V = 2 x 70 W
 Portare il cavo nel veicolo, regolarlo in lunghezza e collegarlo al quadro tramite commutatore.

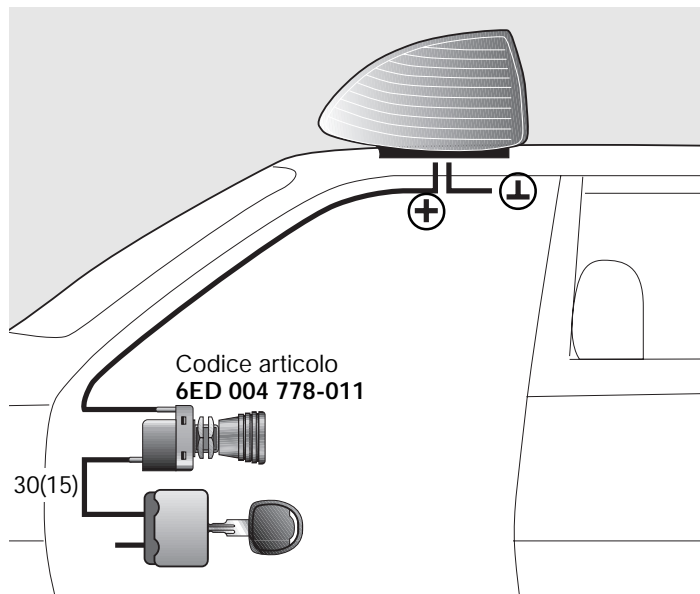

- Cavo bianco = positivo sotto fusibile, commutatore con spia (vedi ricambi)
- Cavo blu = negativo
- Illuminazione pannello: nero, marrone

4.0 Dati tecnici

Dati tecnici OWS Hella

Dati tecnici generali	
Larghezza	~ 300 mm
Altezza (senza base)	~ 180 mm
Peso:	
OWS 540	~ 3,0 kg
OWS 1000	~ 5,5 kg
OWS 1400	~ 7,0 kg
OWS 1600	~ 8,0 kg
Tipo di protezione: IP 5K4K9K (lavaggio ad alta pressione)	
Temperatura di esercizio:	da - 40 °C a + 60 °C
Temperatura di immagazzinamento:	da - 40 °C a + 85 °C
Tensione di esercizio:	(U _N) 12 V e 24 V
Campo tolleranza tensione	
12 V	10...15,5 V
24 V	20...31,0 V
Assorbimento proiettori girevoli:	
	2 x 4,7 A (12 V)
	2 x 2,7 A (24 V)
Plastica con scritta illuminata	~4 A (12 V) ~2 A (24 V)

Dati tecnici dei sistemi ottici

Trasmissione: vite senza fine

N° giri nominali: 160 giri/min

Parabola verniciata argento
con lampadina verticale (versione gialla)

Parabola alluminata a specchio
con lampadine montate (versione blu)

Lampadina alogena H1:
12 V / 55 W; 24 V / 70 W

Plastica PMMA bianco latte

Plastica luminosa giallo = PC
 blu = PMMA

Schermatura radio secondo VDE 879 parte 3

Grado antidisturbo 5

Schermatura per veicoli circostanti

Omologazione: blu B1 E1 00817
 giallo A1 E1 00774
 CE e1 021309

5.0 Versioni disponibili / Ricambi

Sistema completo

Tipo OWS	Versione	Codice articolo
OWS-540	12 V, 2KL, giallo	2RL 007 900-501
OWS-540	12 V, 2KL, blu	2RL 007 900-551
OWS-540	24 V, 2KL, giallo	2RL 007 900-511
OWS-540	24 V, 2KL, blu	2RL 007 900-561
OWS-540 magnete	12 V, 2KL, giallo	2RL 007 900-521
OWS-540 magnete	12 V, 2KL, blu	2RL 007 900-571
OWS-1000	12 V, 2KL, giallo	2RL 007 900-001
OWS-1000	12 V, 2KL, blu	2RL 007 900-151
OWS-1400	12 V, 2KL, giallo	2RL 007 900-201
OWS-1400	24 V, 2KL, giallo	2RL 007 900-211
OWS-1400	12 V, 2KL, blu	2RL 007 900-251
OWS-1600	12 V, 2KL, giallo	2RL 007 900-601
OWS-1600	24 V, 2KL, giallo	2RL 007 900-611
OWS-1600	12 V, 2KL, blu	2RL 007 900-651
Calotta gialla, sinistra		9EL 861 912-001
Calotta gialla, destra		9EL 861 913-001
Calotta blu, sinistra		9EL 861 912-021
Calotta blu, destra		9EL 861 913-021
Motorino		9MN 860 677-021
Riflettore (giallo)		9DX 861 872-001
Riflettore (blu)		9DX 861 976-001
Lampadina alogena		
12 V-55 W		8HG 002 089-131
24 V-70 W		8HG 002 089-251

Ricambi

6.0 Accessori

Basi in gomma

Le basi in gomma si adattano esattamente ai quattro modelli OWS in programma e sono prodotte in materiale ecologico resistente alle intemperie.

Le basi in gomma rappresentano il punto d'appoggio ideale per l'OWS sul tetto dell'automezzo contro attriti e vibrazioni, costituendo un'unità armonica con l'automezzo stesso.

OWS 540

Base in gomma di serie

Lunghezza: 320 mm
Codice articolo
9GD 862 086-001

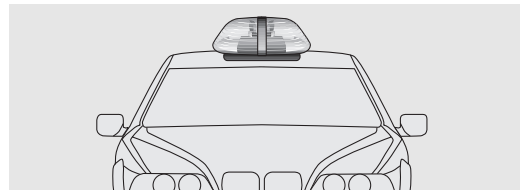
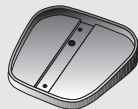

OWS 1000

Lunghezza: 751 mm
Codice articolo
9GD 862 080-001

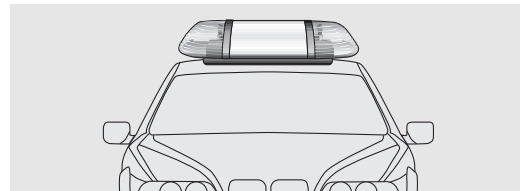
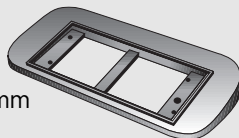

OWS 1400

Lunghezza: 1151 mm
Codice articolo
9GD 862 081-001

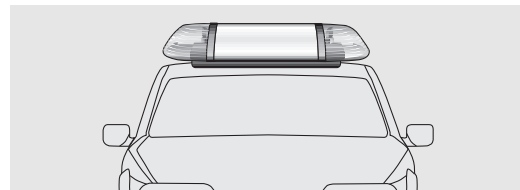
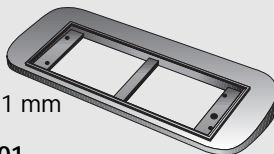

OWS 1600

Lunghezza: 1351 mm
Codice articolo
9GD 862 085-001

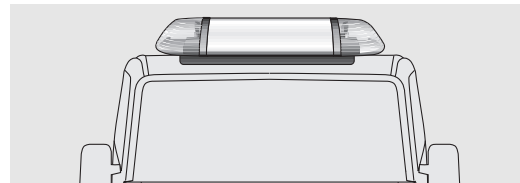
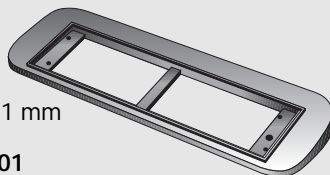

Accessori

Set portante

Il set portante è composto da due parti e va saldato direttamente a un supporto già esistente.

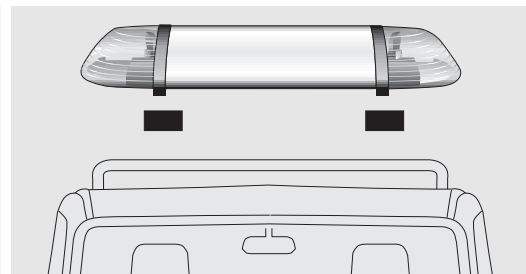
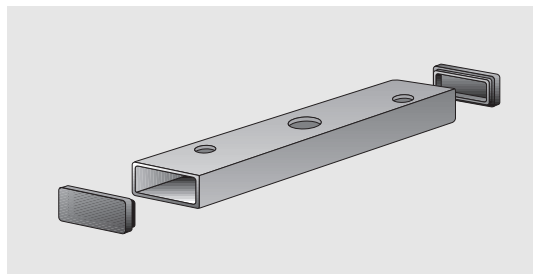

Elemento di supporto per montaggio diretto

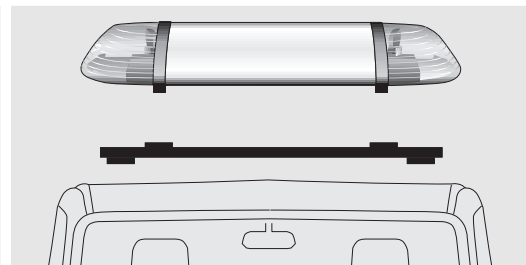
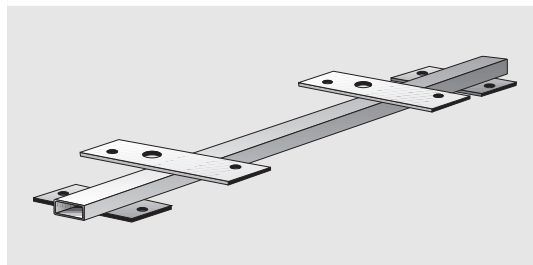

Sistema di fissaggio 9DX 857 445-001

Tirante a staffa 9XD 857 421-801

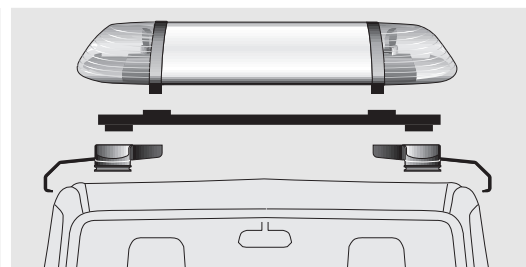
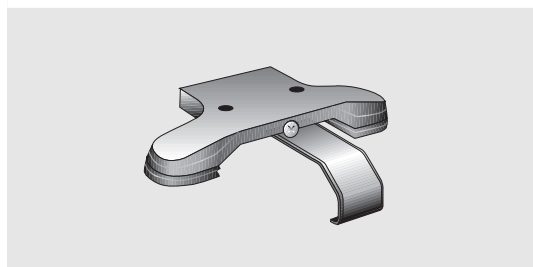

Portalampane (con lampade montate)

Dotazione: OWS 1000 (1 x)
OWS 1400 (2 x)
OWS 1600 (2 x)

Codice articolo

9FT 861 790-001 12 V

9FT 861 790-011 24 V

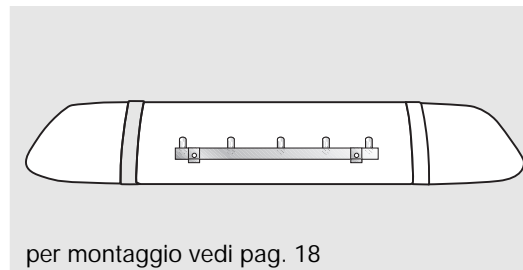
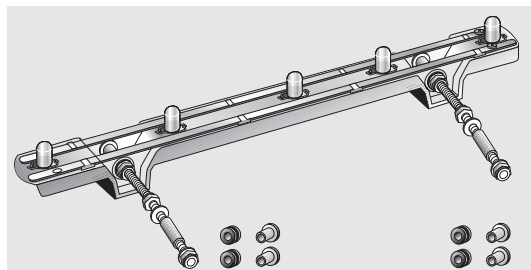

per montaggio vedi pag. 18

Lampadine (ricambi)

Illuminazione della plastica
luminosa

5 x 5 W oppure 10 x 5 W
per montaggio successivo

Codici articolo

9GP 003 594-131 12 V

9GP 003 594-251 24 V

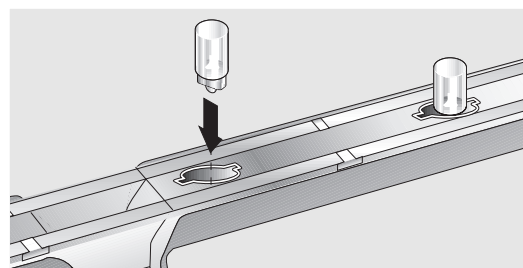
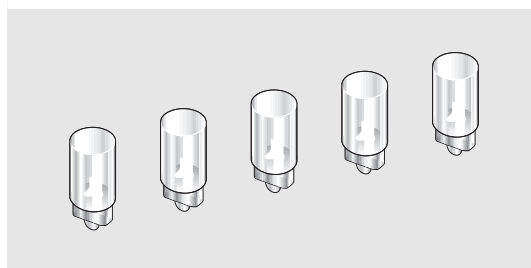

Commutatore con spia

1 pezzo
per illuminazione plastica

1 pezzo
per funzionamento proiettori
girevoli

Codice articolo

6ED 004 778-011

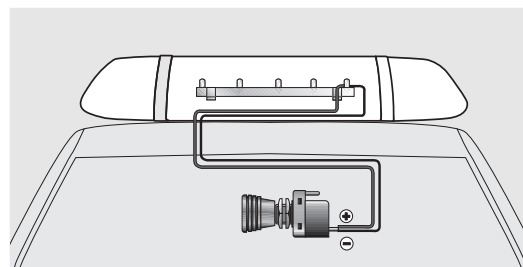
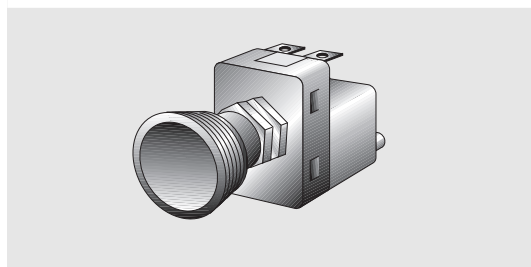

Accessori

Montaggio
gruppo illuminazione
plastica

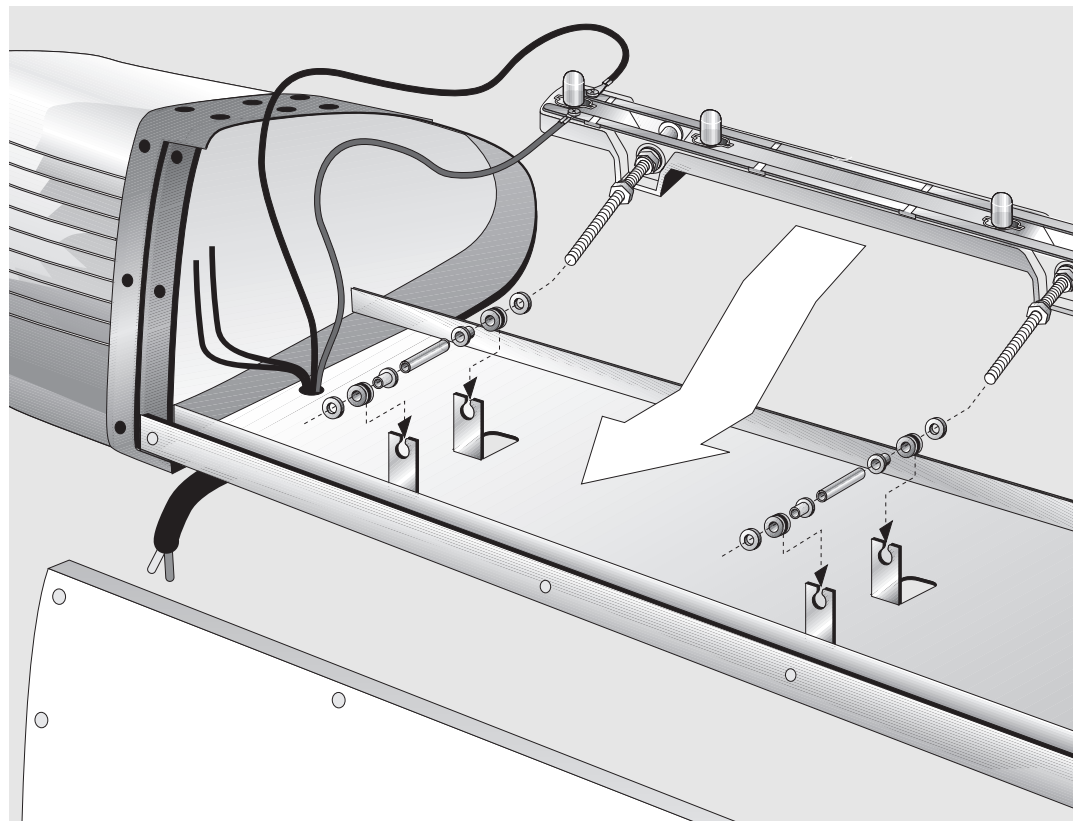

7.0 Ricerca eventuali difetti

Proiettore girevole

Proiettore girevole	possibile causa	
Uno o ambedue sono spenti pur con parabole rotanti.	Accertarsi dello stato delle lampadine.	
La parabola non gira, ma le lampadine sono accese.	Controllare se la trasmissione o il motorino sono in ordine.	
Ambedue i proiettori spenti e parabole ferme.	Controllare il passaggio di corrente all' entrata o all' uscita	si = Controllare che ci sia corrente al dispositivo, morsetto 72 (motorino)
		no = Connessione 30 alla scatola portafusibili o fusibile difettoso
	Controllare se c' è il collegamento a massa del proiettore girevole.	

Illuminazione parte centrale libera

Difetto	possibile causa	
La scritta non risulta completamente illuminata.	Controllare che una o più lampadine o il fusibile non siano difettosi.	

Se avete domande o problemi di installazione, il Servizio Assistenza Clienti Hella è a vostra disposizione al seguente numero telefonico:

① **02.98.835.1**

Fuori orario d' ufficio una segreteria telefonica riceverà i vostri messaggi e le vostre richieste.

Il Servizio Assistenza Clienti Hella vi richiamerà appena possibile.

Hella s.p.a.
Via Piemonte, 17
Fraz. Sesto Ulteriano

20098 San Giuliano Milanese

Hellan optiset varoitusjärjestelmät OWS

Tekninen käsikirja

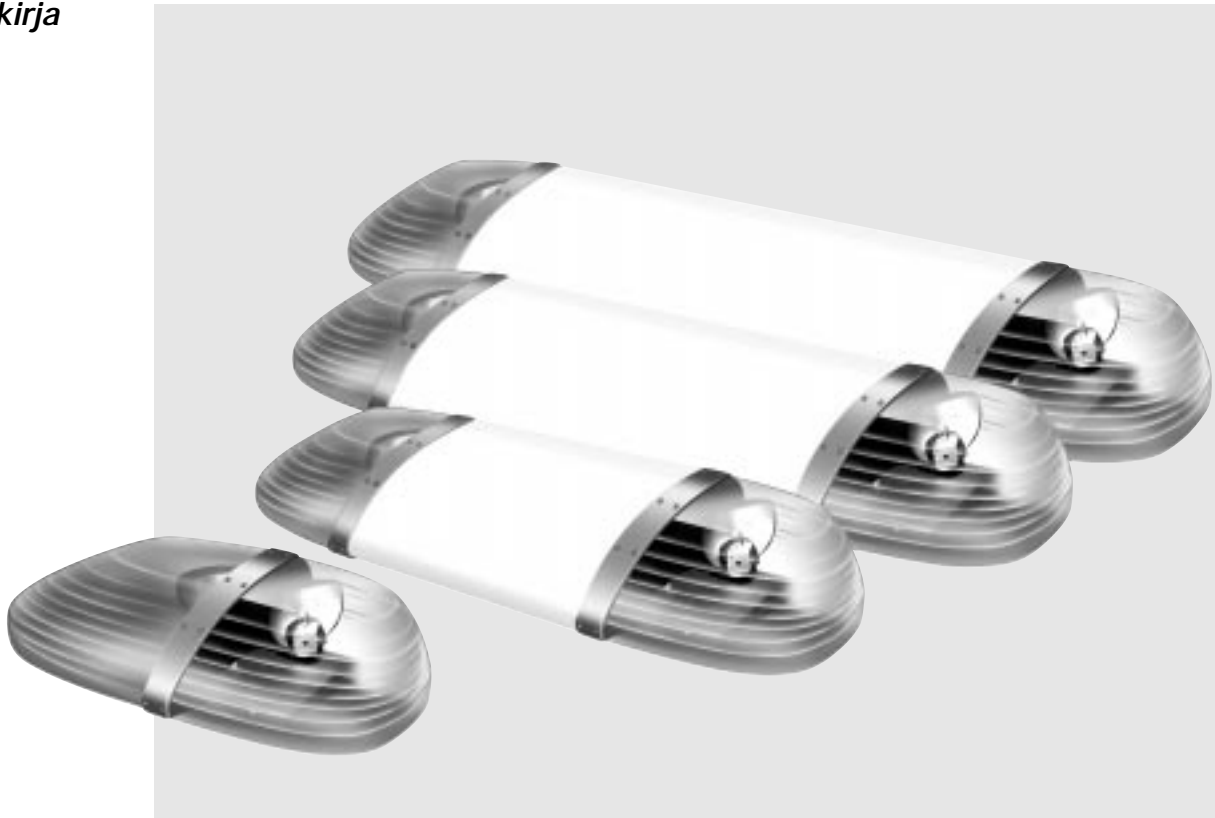

Lue ennen asennuksen alkua nämä asennus- ja käyttöohjeet huolellisesti läpi ja noudata annettua asennusjärjestystä. Asianmukaisesti suoritettu asennus takaa ajoneuvon käyttövarmuuden ja turvallisuuden.

Tekninen käsikirja

Hellan optinen varoitusjärjestelmä OWS

Sisällysluettelo

	Sivu
1.0 Yleistä	144
2.0 Asennus	146
3.0 Sähköliitäntä	152
4.0 Tekniset tiedot	153
5.0 Eri OWS-versiot / varaosat	154
6.0 Tarvikkeet	155
7.0 Vianetsintä	159

1.0 Yleistä

Järjestelmä ja toiminnot

Hella OWS on kompaktijärjestelmä tietyö- ja kunnossapitoajoneuvoille, tiepalveluautoille, ylipitkille tai ylileveille moottoriajoneuvoille. Se on varustettu keltaisilla

majakoilla ja sisältäpäin valaistulla paneelilla, johon on mahdollista lisätä oma teksti. OWS-varoitussjärjestelmää on saatavana myös sinisillä majakoilla.

Hella OWS koostuu seuraavista osista:

- keltaiset majakat (kaksi majakkaa, kääntyvyys 360°, pyörivällä heijastajalla ja H1-halogeeni-polttimolla),
- paneelit, joihin teksti jälkikäteen; lisävarusteena sisältäpäin valaiseva valokisko (viisi tai kymmenen rinnakkain asennettua polttimoa)

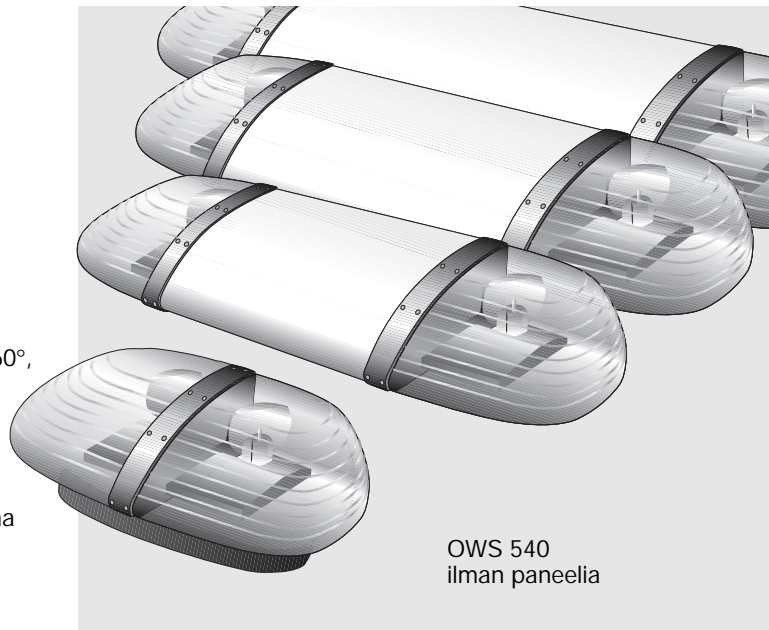

OWS 540
ilman paneelia

**Useita
käyttämahdollisuuksia**
OWS:n laajat paneelit antavat
mahdollisuudet moninaisille
teksteille.

Etumainen ja takimmainen
paneeli mahdollistaa tekstin
painamisen ongelmitta
valintasi mukaan.

Hälytysajoneuvoissa
huomatuksi tuleminen
tehostuu informoivalla tekstillä.

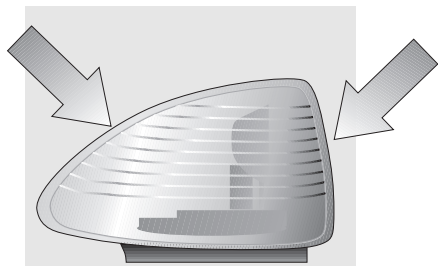
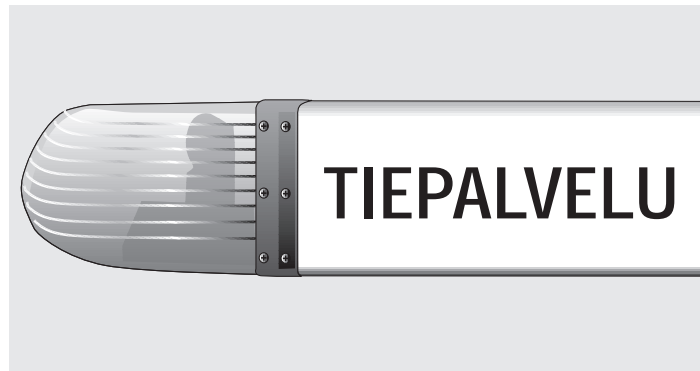

Teksti on mahdollista
kirjoittaa molemmin puolin.

Molempien majakoiden
valossa teksti on
tunnistettavissa huonoissakin
sääolosuhteissa.

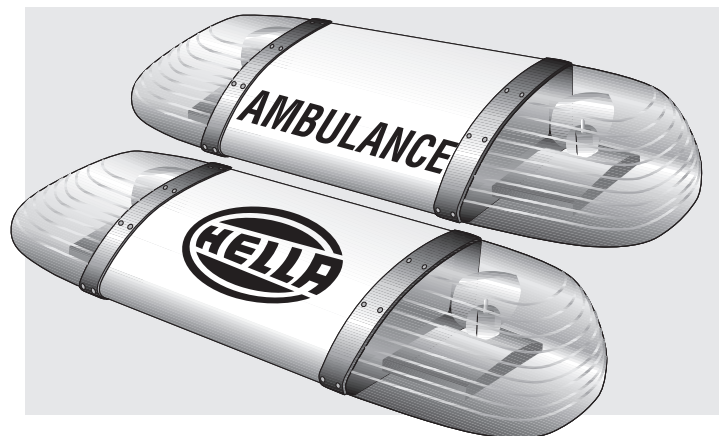

2.0 Asennus

Ennen asennusta on ajoneuvon valmistajan kanssa neuvoteltava katon kestävydestä.

Tasaisen asennuskohdan valinta ja kiinnityksen valmistelu asennustavasta riippuen.

Huomio:

Asennuksen jälkeen sekä ennen ajoa on tarkistettava, että laite on tukevasti paikallaan ja liitokset lujasti kiinni.

2.1 Kiinteä asennus

Merkitse mittapiirustuksen avulla OWS:n ääriiviivat ajoneuvon katolle. Huomioi katon kaarevuus.

Irrota katon sisäverhous. Poraamalla mittapiirustuksen mukaisesti. Vie liitäntäjohto aukon läpi.

Poista lumi, jää ja lika ajoneuvon katolta.

Varo porattaessa vahingoittamasta ajoneuvon muita osia.

Suosittelemme metalliin porattujen aukkojen käsittelemistä ruosteenestoaineella. Sulje asennuksen jälkeen kaapelin läpivientiaukko tiivistävällä liimalla.

Porausmalline
OWS 540

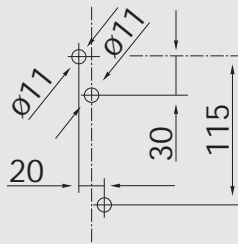

Porausmalline kaikkiin versioihin

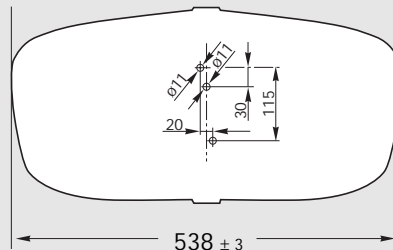

Porausmalline
OWS 1000

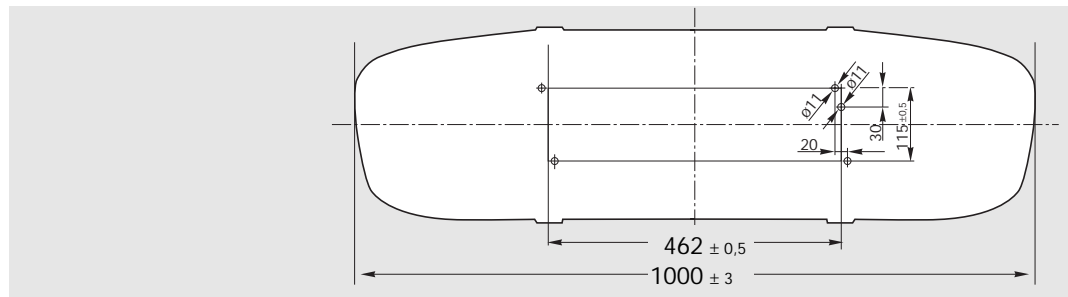

Porausmalline
OWS 1400

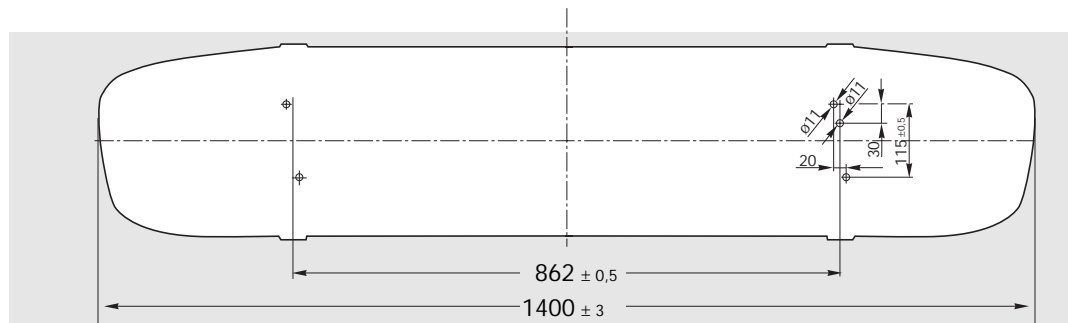

Porausmalline
OWS 1600

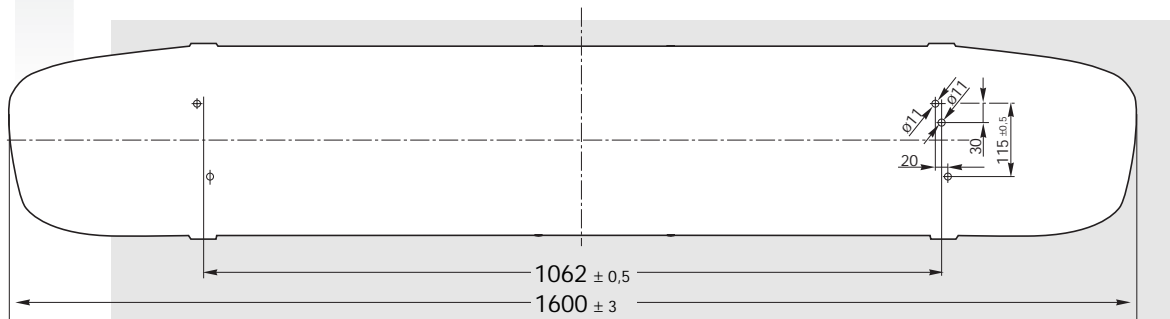

Aseennus

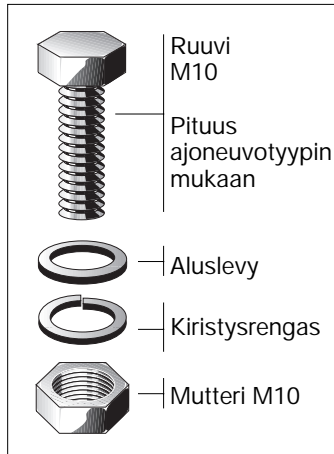

Kiinnitysosat eivät sisälly toimitukseen.

Kiinnitysruuvi
M10

Maks.kiristysmomentti
4 Nm

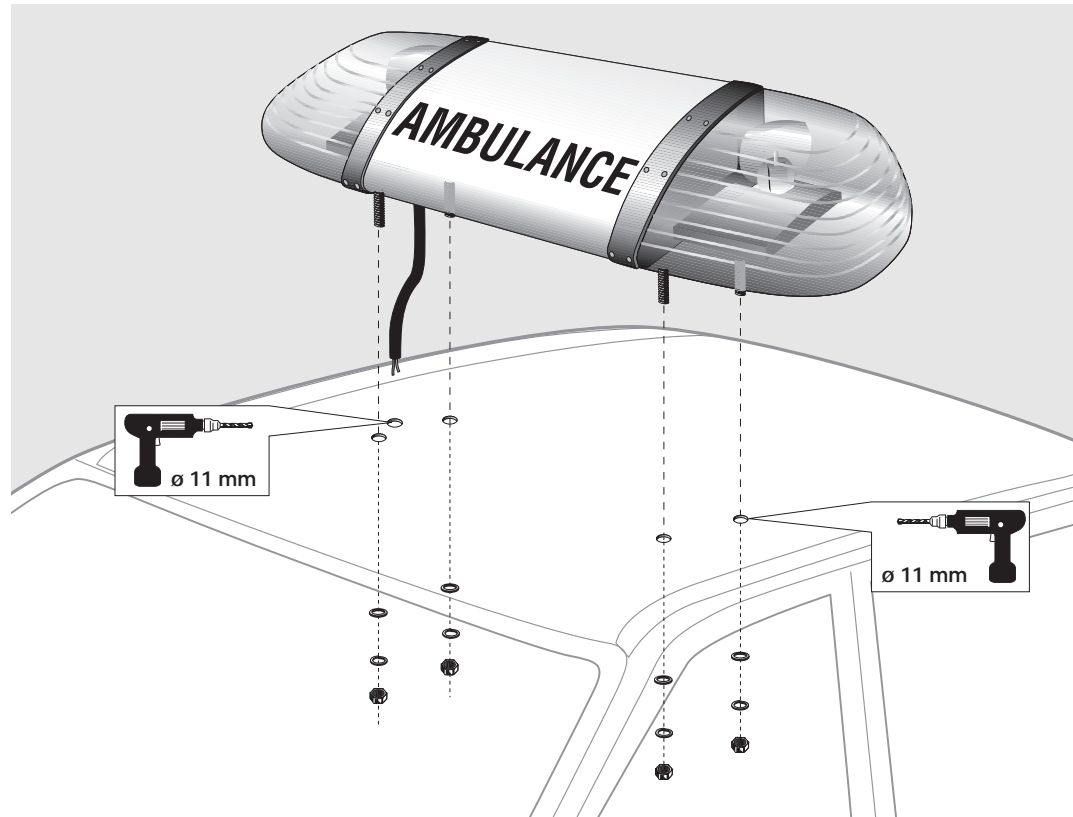

2.1.1 Kiinteä asennus ohessa olevilla kumitiivisteillä

(ei mahdollinen OWS 540)

Aseta kiinnitysruuvit M 10 kannattimen kiinnityskohtiin oikealle ja vasemmalle.

Paina kumitiiviste asennusjalkaan.

Vie liitäntäkaapeli aukon kautta, aseta kiinnitysruuvit ajoneuvon katolle ennalta porattuihin aukkoihin, aseta laite paikoilleen ja ruuvaa lujasti kiinni.

Tarkasta kiinnityksen jälkeen, että majakat ovat suorassa.

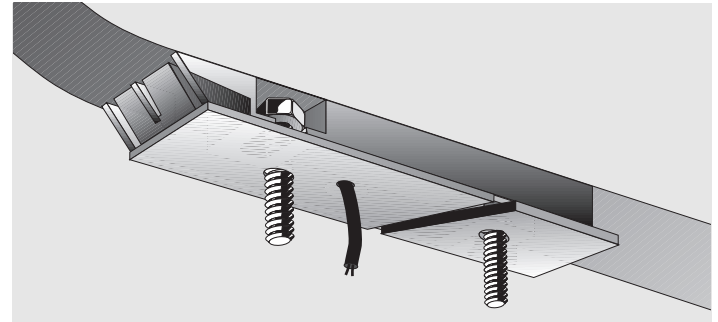
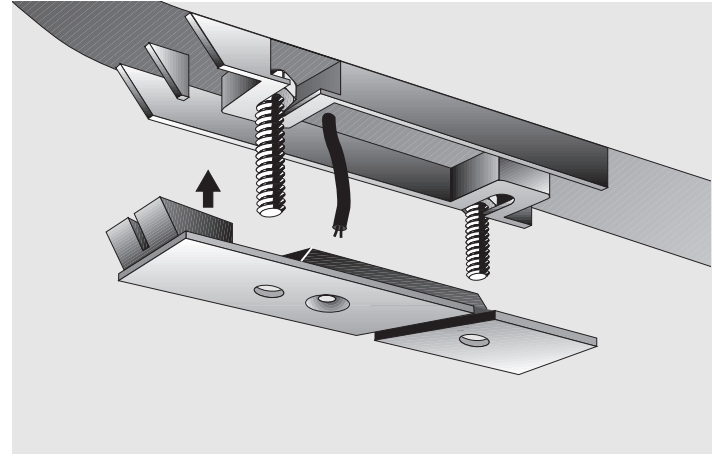

2.1.2 Kiinteä asennus isoa kumialustaa apuna käyttäen

Ohessa olevia tiivisteitä ei tarvita.

Aseta kiinnitysruuvit M 10 kannattimen kiinnityskohtaan oikealle ja vasemmalle.

Aseta kumialusta OWS:n alapuolelle.

Aseta laite ajoneuvon katolle. Vie kaapeli aukon läpi ja aseta ruuvit niitä varten porattuihin aukkoihin.

Kiinnitä OWS lujasti ruuveilla.

Tarkasta kiinnityksen jälkeen, että majakat ovat suorassa. Asentoa voi korjata kiinnitysruuveilla.

Huomioi näkyvyys 360°!



2.2 Sankakiinnitys

(ks. Tarvikkeet kappale 6.0)

Kiinteän asennuksen vaihtoehtona on sankakiinnitys. Tällöin porataan ainoastaan kaapeliaukko. Ohessa ovat kumitiivisteet painetaan OWS:n asennusjalkaan?

2.3 Magneettikiinnitys

Magneettijalalla varustettu OWS 540 mahdollistaa koko majakkayksikön nopean käyttöönoton.

Tämän OWS-version saa asettaa ainoastaan peltikatolle!

Kiinnityspinnan tulee olla puhdas liasta, vedestä, lumesta ym.

Kiinnikesarja 9DX 857 445-001 asennetaan pidikkeen alle.

Sen jälkeen koko järjestelmä kiinnitetään ruuvaamalla kumitiivisteellä varustettuun OWS:ään.

Kiristysangat sovitettava kyseessä olevaan ajoneuvoon.

Huom.! Suurin sallittu ajonopeus 120 km/h.

Sähköliitäntä (johdotus) DIN-pistorasiaan voidaan tehdä avoimen ikkunan kautta, jolloin on varmistettava, että liitäntäjohto ei joudu puristuksiin eikä taitu.

Kun laite ei ole käytössä, sitä on säilytettävä asianmukaisesti!

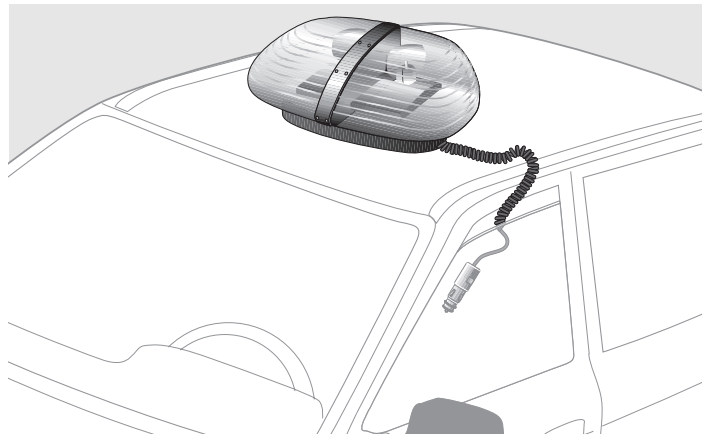
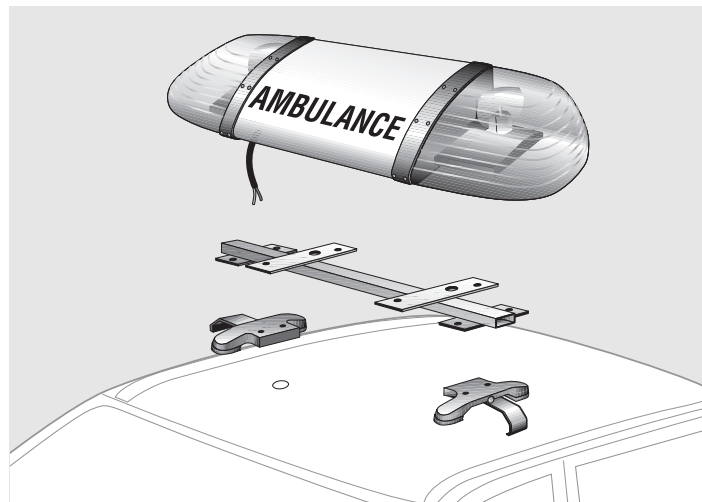

3.0 Sähköinen liitäntä

Auton akku on irrotettava ennen asennuksen aloitusta. Kaapelisarja on parasta viedä ajoneuvon A-pilarin kautta eteen. Vältettävä jyrkkiä mutkia ja teräviä kulmia.

Majakat:
 12 V = 2 x 55 W;
 24 V = 2 x 70 W
 Vie johto ajoneuvon, lyhennä ja yhdistä kytkimeen.

- Plusjohto = valkoinen (varusta sulakkeella, kytkin merkivalolla - lisävaruste)
- Maadoitusjohto = sininen
- Jälkiasennuksena esim. sisävalaistus: musta, ruskea

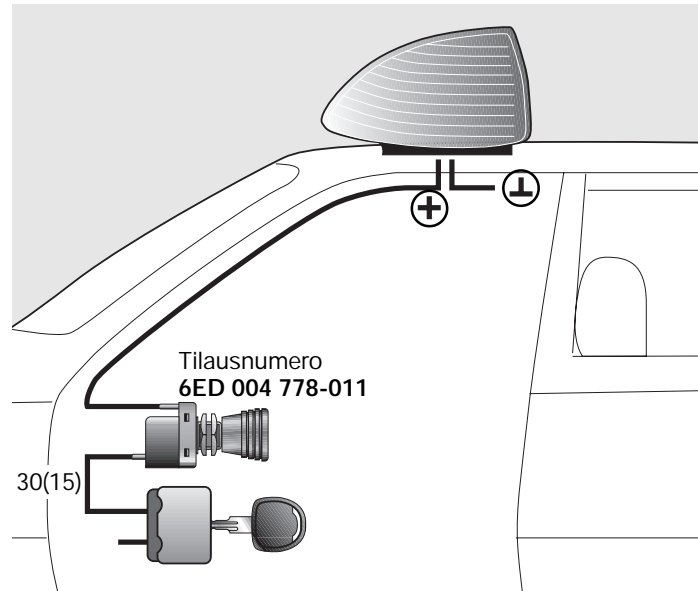

4.0 Tekniset tiedot

Tekniset tiedot - Hella OWS

Yleiset tekniset tiedot	
Leveys	~ 300 mm
Korkeus (ilman aluslevyä)	~ 180 mm
Paino:	
OWS 540	~ 3.0 kg
OWS 1000	~ 5.5 kg
OWS 1400	~ 7.0 kg
OWS 1600	~ 8.0 kg
Suojaus	IP 5K4K9K (painepesu)
Toimintalämpötila:	- 40 °C - + 60 °C
Varastolämpötila:	- 40 °C - + 85 °C
Käyttöjännite:	(U _N)12 V ja 24 V
Käyttöjännitealue:	
12 V	10...15.5 V
24 V	20...31.0 V
Virrankulutus	
Majakat	2 x 4,7 A (12 V) 2 x 2,7 A (24 V)
Paneeli valaistuna	~4 A (12 V) ~2 A (24 V)

Tekniset tiedot optisille järjestelmille

Toiminta: simpukkaveto

Nimelliskierros-luku: 160 r/min.

Hopeanväriiseksi maalattu
paraboloidiheijastaja, polttimo
pystyasennossa (keltainen versio)

Erittäin kirkas tyhjämetalloitu
paraboloidiheijastaja integroidulla polttimolla
(sininen versio)

H1-polttimo:
Halogeeni 12 V / 55 W; 24 V / 70 W

Paneelin materiaali PMMA maidonvalkea

Majakkan lasin
materiaali keltainen = PC
sininen = PMMA

Radiohäiriösuojaus: VDE 879 osa 3

suoja-aste 5,

häiriösuojaus lähellä oleville ajoneuvoille

Tyyppi hyväksyntä: sininen B1

E1	00817
----	-------

keltainen A1

E1	00774
----	-------

CE

e1	021309
----	--------

5.0 Eri OWS-versiot / varaosat

Täydelliset järjestelmät

OWS-tyyppi	Majakkatyyppi	Tilausnumero
OWS-540	12 V, 2KL, keltainen	2RL 007 900-501
OWS-540	12 V, 2KL, sininen	2RL 007 900-551
OWS-540	24 V, 2KL, keltainen	2RL 007 900-511
OWS-540	24 V, 2KL, sininen	2RL 007 900-561
OWS-540 magneetti	12 V, 2KL, keltainen	2RL 007 900-521
OWS-540 magneetti	12 V, 2KL, sininen	2RL 007 900-571
OWS-1000	12 V, 2KL, keltainen	2RL 007 900-001
OWS-1000	12 V, 2KL, sininen	2RL 007 900-151
OWS-1400	12 V, 2KL, keltainen	2RL 007 900-201
OWS-1400	24 V, 2KL, keltainen	2RL 007 900-211
OWS-1400	12 V, 2KL, sininen	2RL 007 900-251
OWS-1600	12 V, 2KL, keltainen	2RL 007 900-601
OWS-1600	24 V, 2KL, keltainen	2RL 007 900-611
OWS-1600	12 V, 2KL, sininen	2RL 007 900-651
Majakan lasi keltainen vasen		9EL 861 912-001
Majakan lasi keltainen oikea		9EL 861 913-001
Majakan lasi sininen vasen		9EL 861 912-021
Majakan lasi sininen oikea		9EL 861 913-021
Moottori		9MN 860 677-021
Heijastaja (keltaiseen versioon)		9DX 861 872-001
Heijastaja (siniseen versioon)		9DX 861 976-001
Halogeenipolttimo		
12 V-55 W		8HG 002 089-131
24 V-70 W		8HG 002 089-251

Varaosat

6.0 Tarvikkeet

Kumialusta

Kumialustat on mukailtu näille neljälle OWS-mallille ja ne on valmistettu ympäristöystävällisestä, säänvaihtelut kestävästä materiaalista.

OWS:n kumialusta on kulutuksenkestävä ja värinän alusta ajoneuvon katolla ja se muodostaa ajoneuvon kanssa optisesti suljetun kokonaisuuden.

OWS 540 Kumialusta vakiovaruste

Pituus: 320 mm
Tilausnumero
9GD 862 086-001

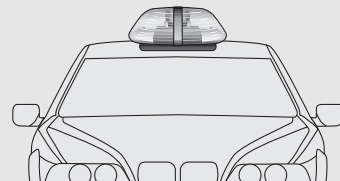
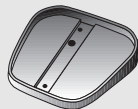

OWS 1000

Pituus: 751 mm
Tilausnumero
9GD 862 080-001

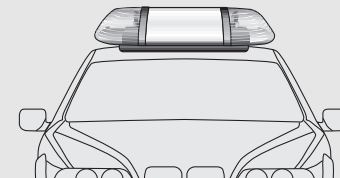
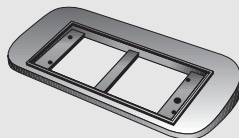

OWS 1400

Pituus: 1151 mm
Tilausnumero
9GD 862 081-001

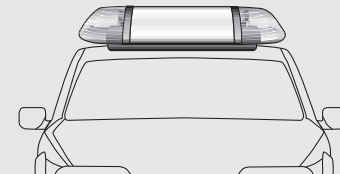
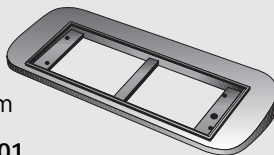

OWS 1600

Pituus: 1351 mm
Tilausnumero
9GD 862 085-001

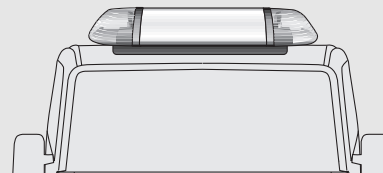
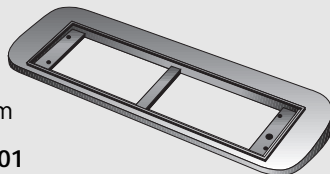

Tarvikkeet

Kannatinsarja

Kannatinsarja koostuu kahdesta osasta ja se hitsataan suoraan pidikkeeseen.

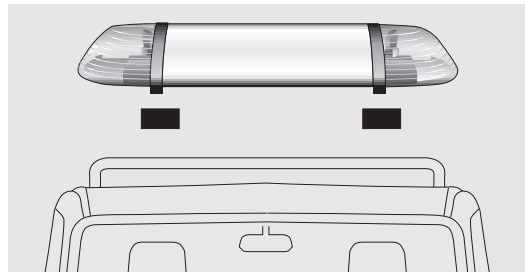
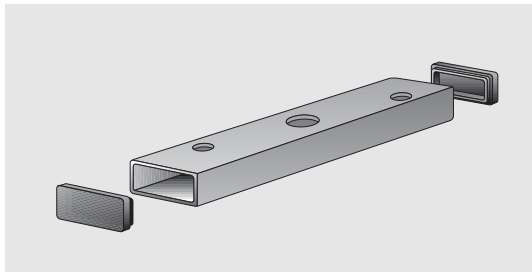

Pidikesarja suora-asennukseen

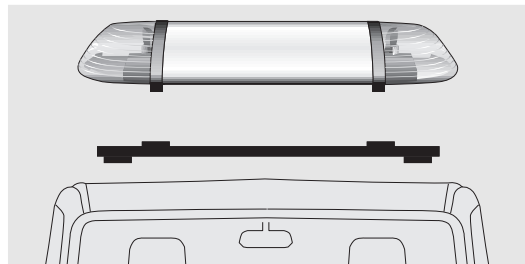
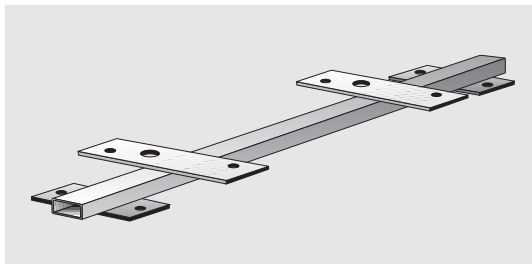

Kiinnikesarja

9DX 857 445-001

Kiristyssankasarja

9XD 857 421-801

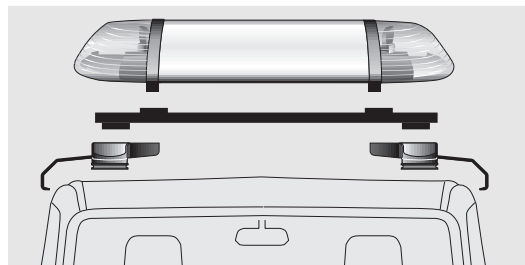
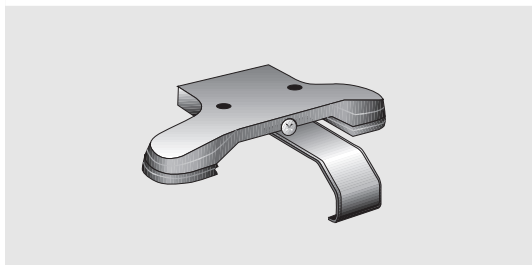

Lampunpidin (sis. polttimot)

Varustus: OWS 1000 (1 x)
OWS 1400 (2 x)
OWS 1600 (2 x)

Tilausnumero

9FT 861 790-001 12 V

9FT 861 790-011 24 V

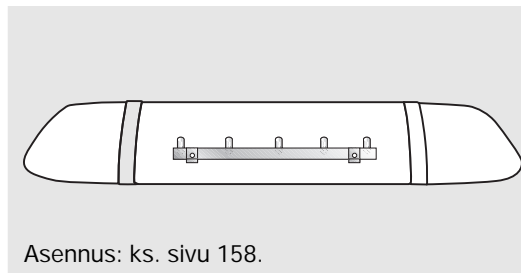
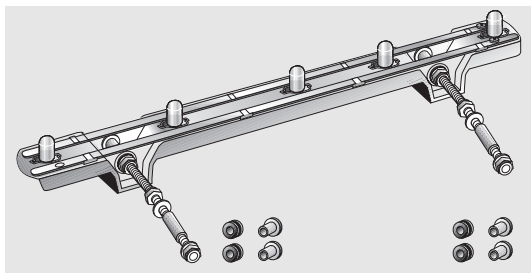

Asennus: ks. sivu 158.

Polttimot (varaosat)

Paneelivalaistus
5 x 5 W tai 10 x 5 W
jälkiasennettavissa

Tilausnumero

9GP 003 594-131 12 V

9GP 003 594-251 24 V

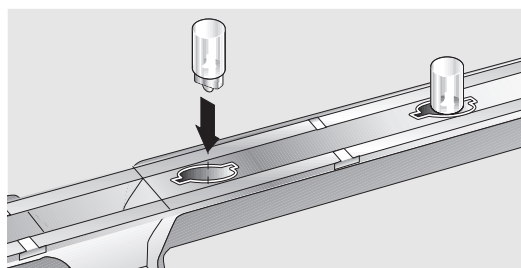
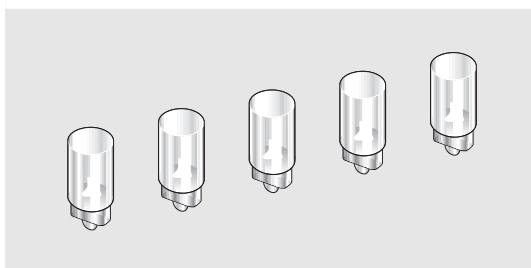

Kytkin merkkivalolla

1 kappale / sisävalaistus

1 kappale / majakat

Tilausnumero

6ED 004 778-011

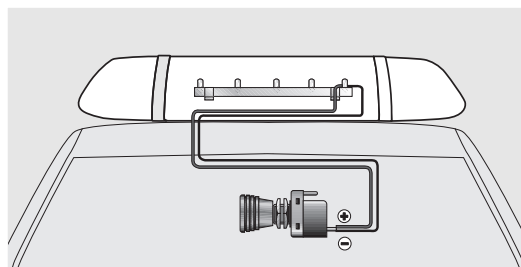
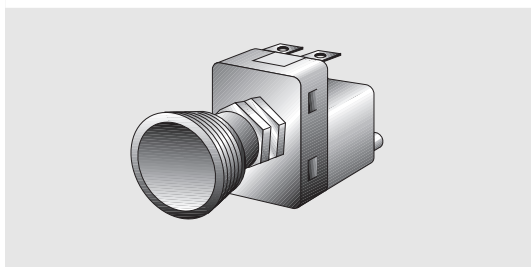

Tarvikkeet

Valaisinkiskon asennus

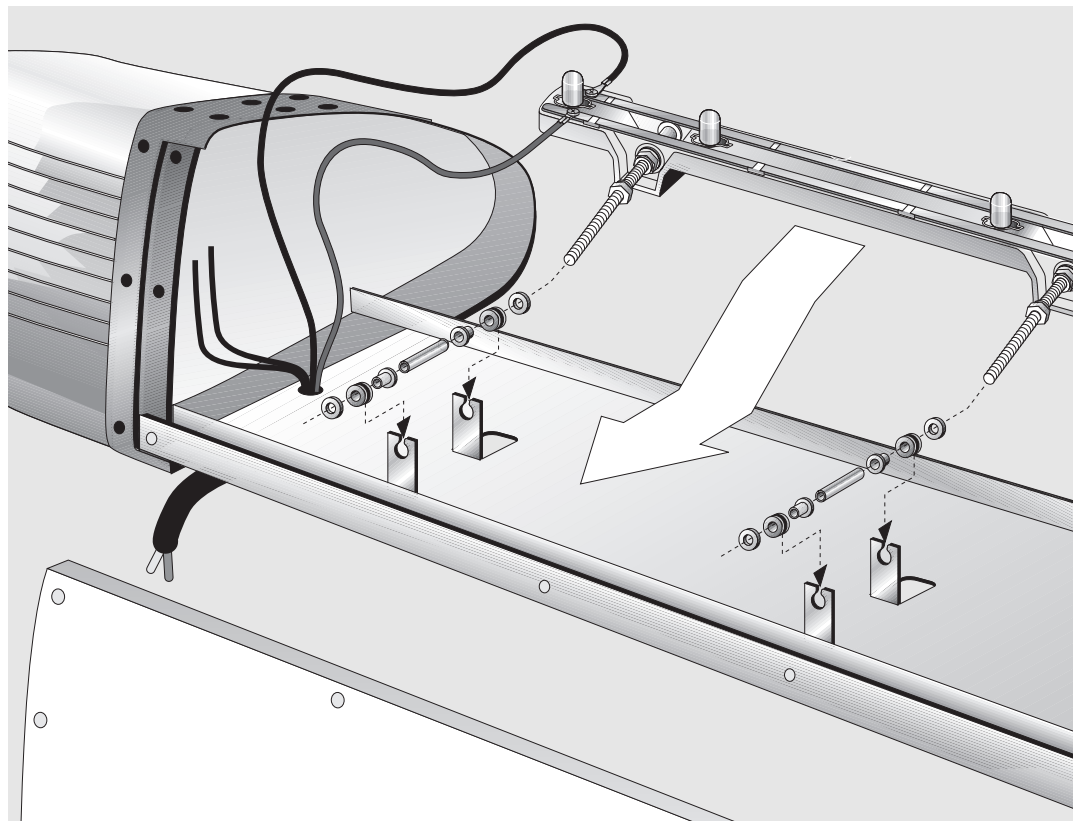

7.0 Vianetsintä

Majakka

Majakka	Mahdollinen syy	
Yksi tai molemmat majakat ovat ilman valoa, vaikka heijastaja pyörii.	Tarkista, onko polttimo viallinen.	
Heijastaja ei pyöri, mutta polttimot ovat kunnossa.	Tarkista, onko hammaspyörät tai moottori viallinen.	
Molemmat majakat ilman valoa, heijastajat eivät pyöri.	Tarkista, onko sulake ehjä.	kyllä = Tarkista, saako laitteen napa 72 (moottori) jännitettä.
		ei = Syöttöjohdon 30 sulake viallinen.
	Tarkista, onko maadoitus kunnossa.	

Paneelin valaistus

Häiriö	Mahdollinen syy
Teksti ei kunnolla valaistu.	Tarkista, onko polttimo tai sulake viallinen.

