

L = 220

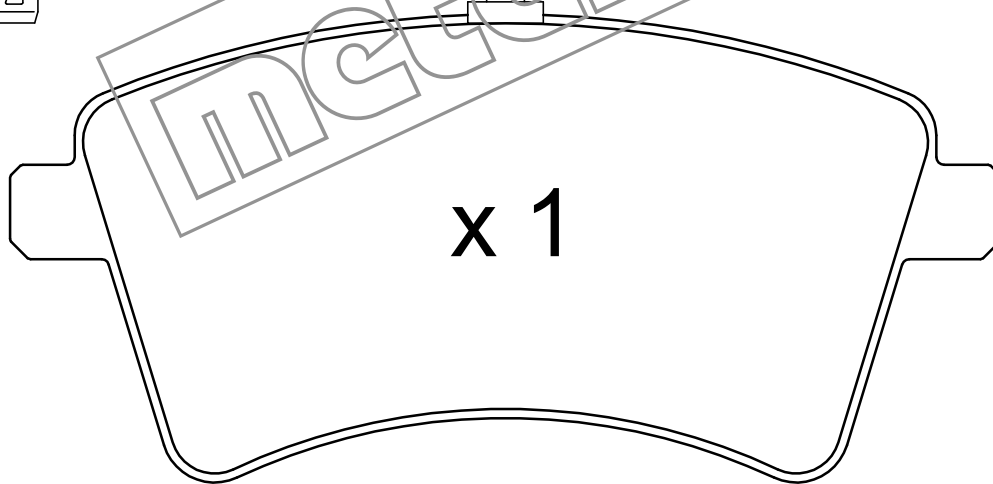

x 1

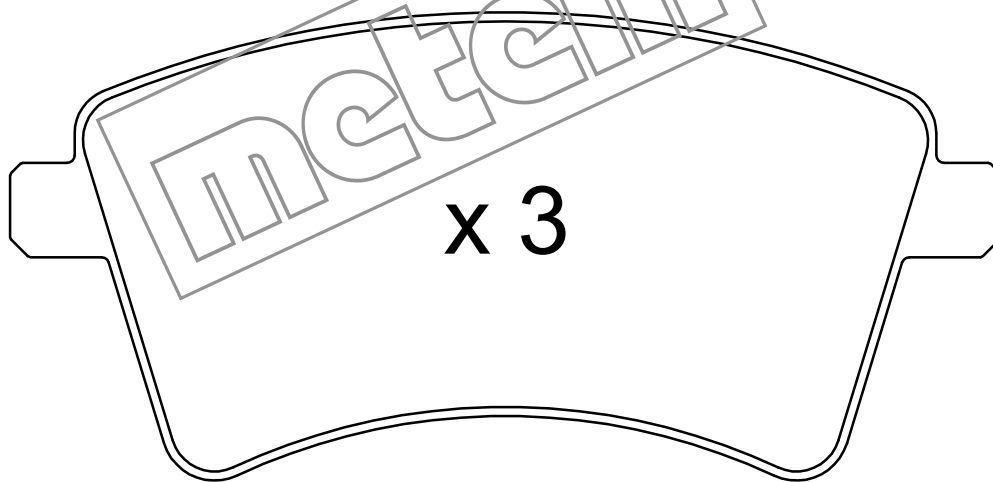
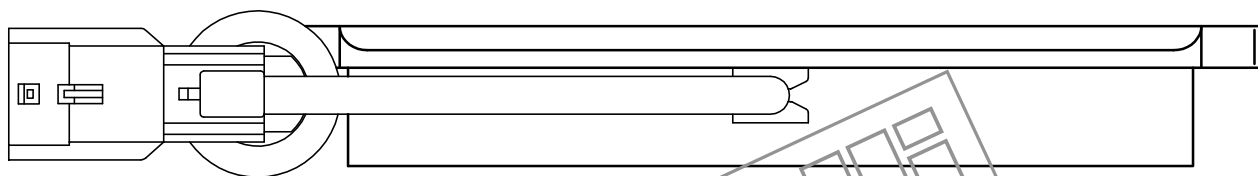

x 3

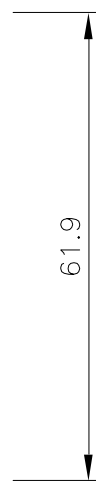

61.9

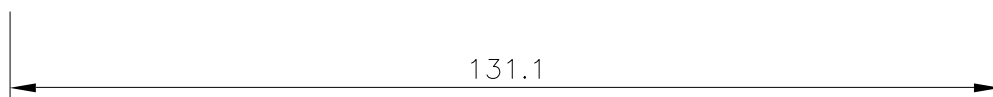

131.1

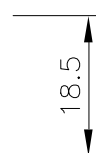

18.5

