

L = 280

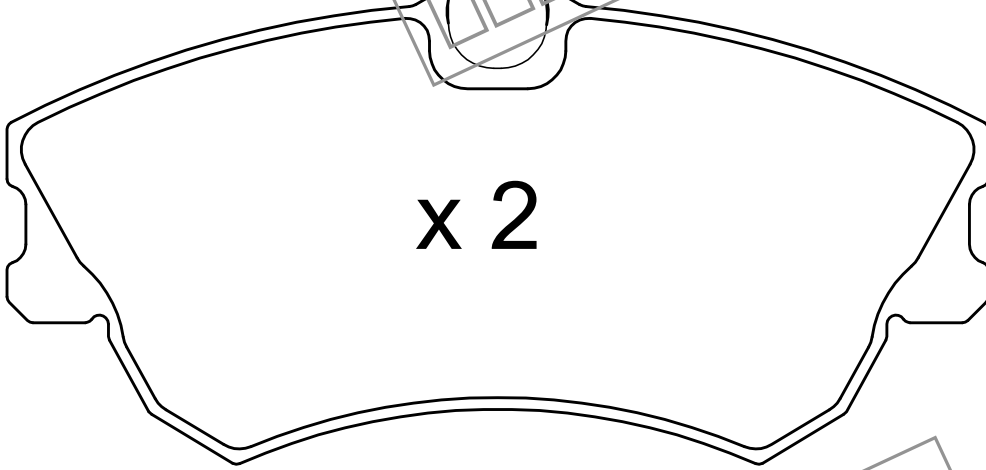

x 2

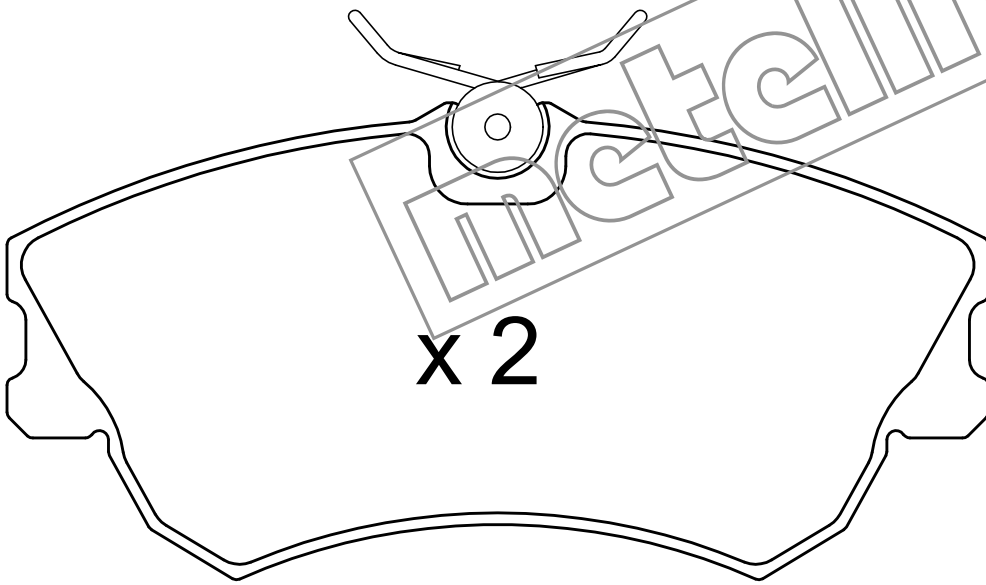
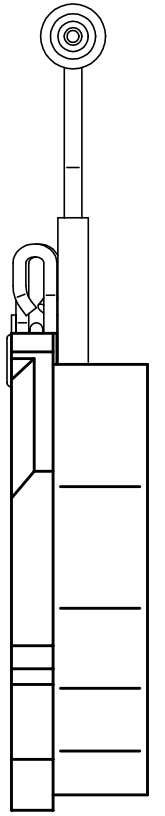

x 2

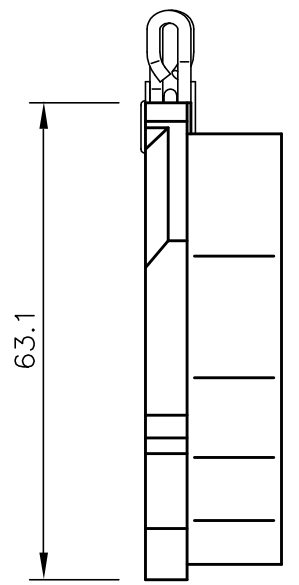

63.1

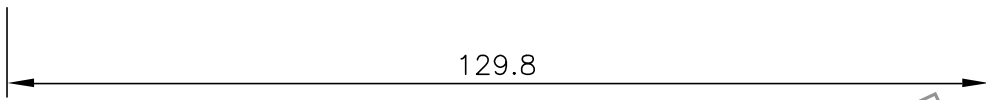

129.8

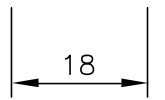

18

