

L = 170

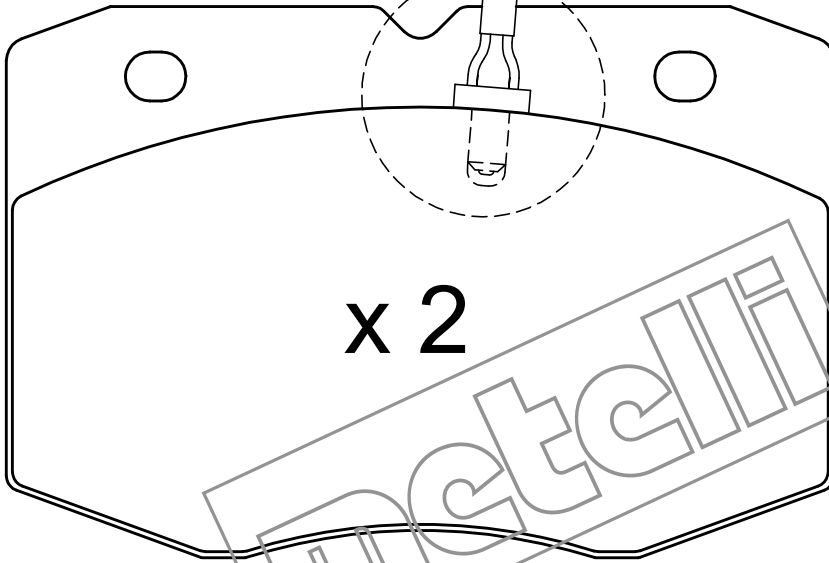

x 2

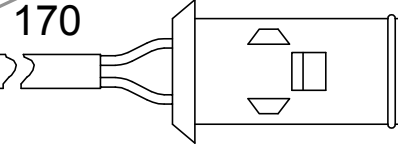
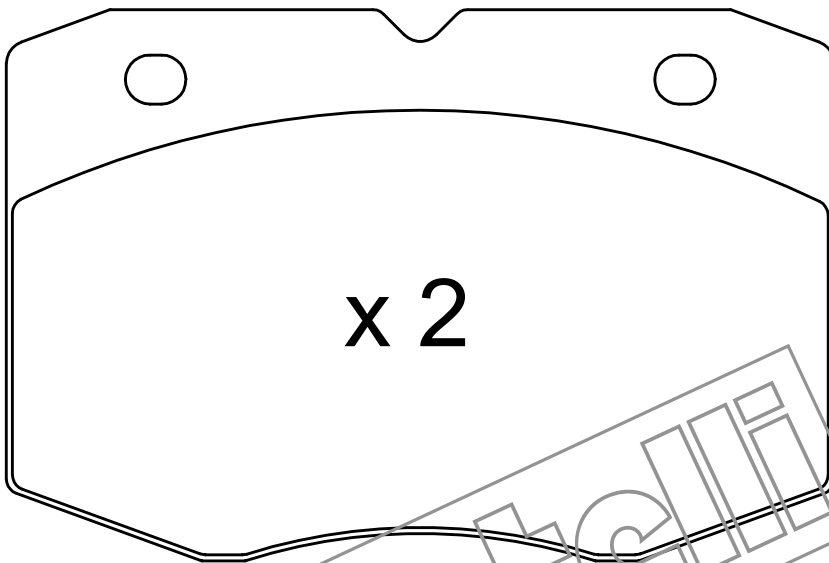
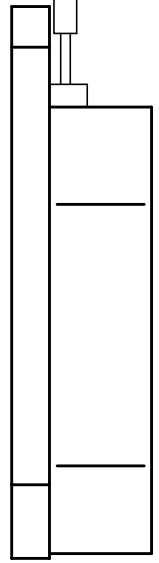

x 2



73.2

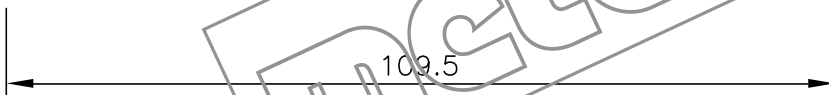
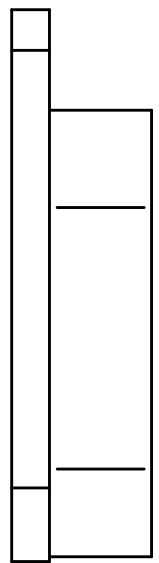

109.5

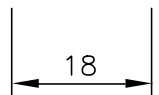

18