

x 2

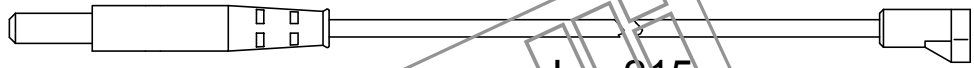

L = 215

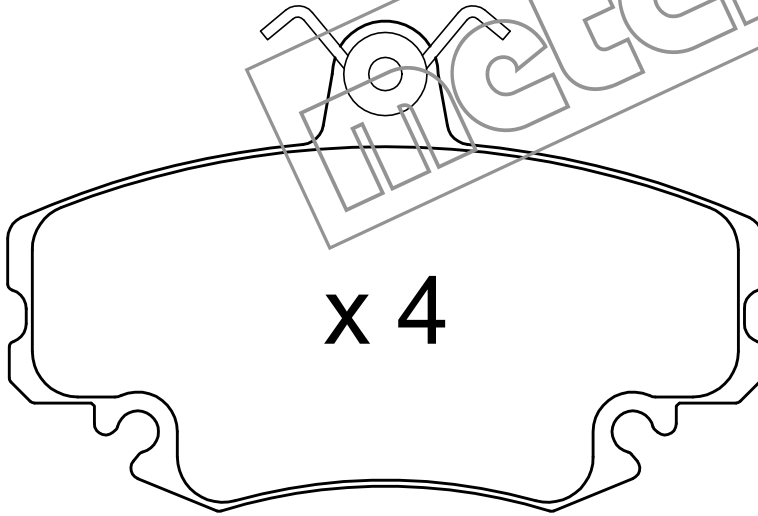

x 4

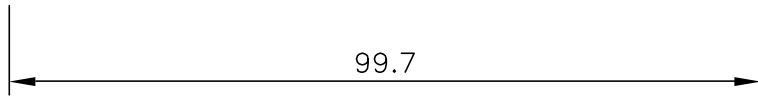

99.7

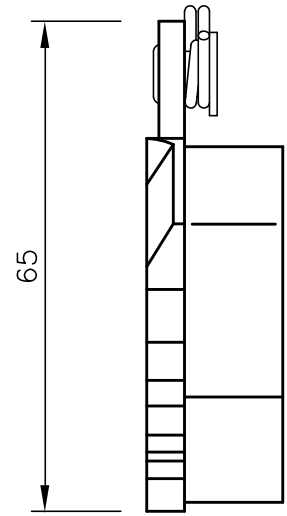

65

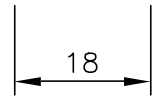

18

metelli

metelli