

L = 120

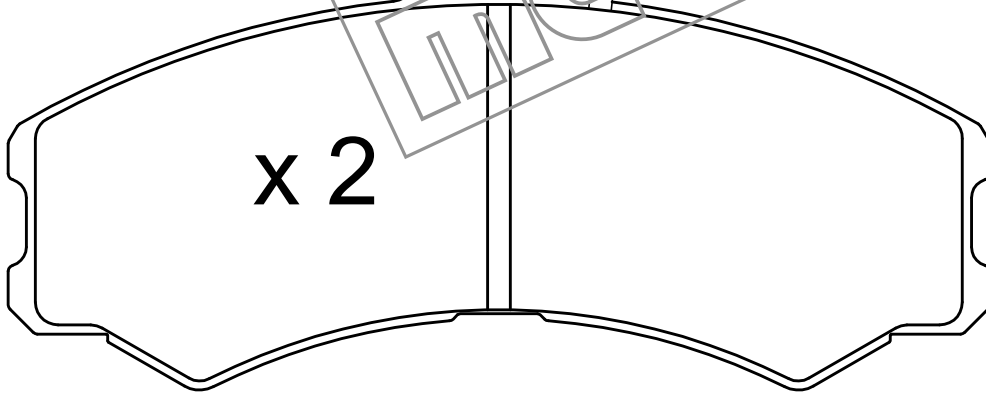

x 2

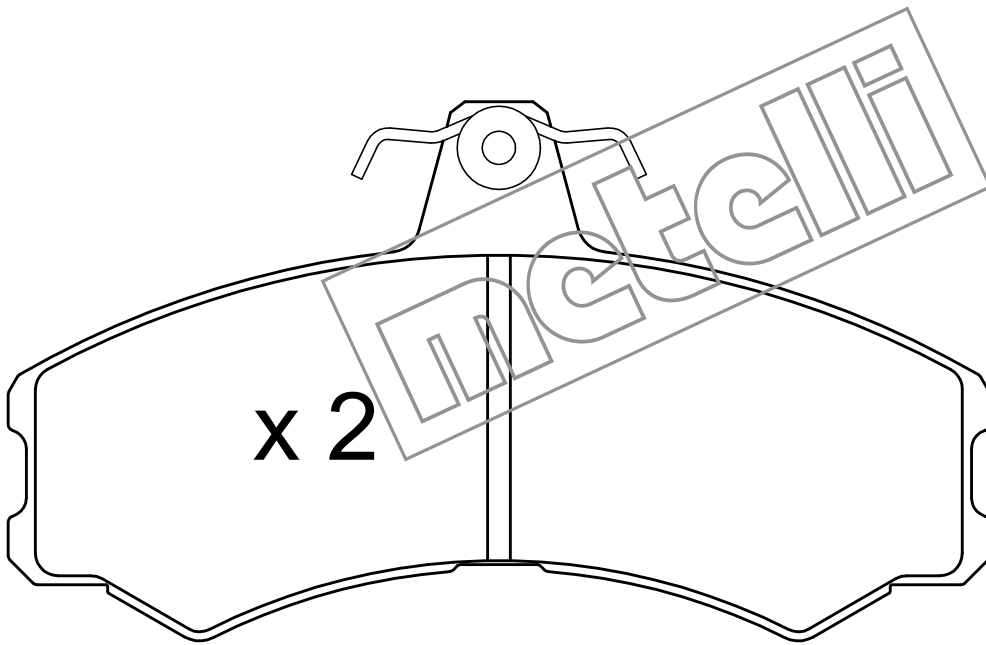
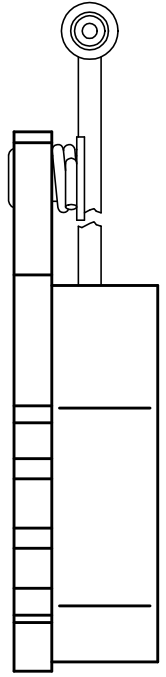

x 2

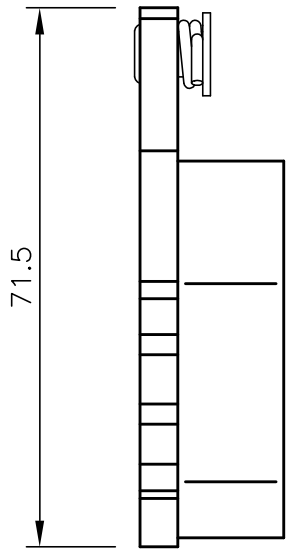

71.5

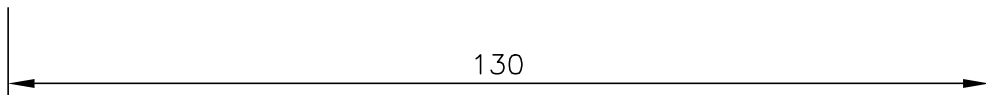

130

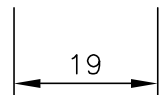

19

