

AGM Battery For passenger vehicles

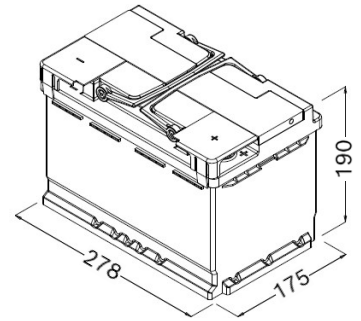

Part information

Part No:	0092PA0080
Short code:	PA008
Product line:	Power AGM
Technology:	AGM - Absorbent Glass Mat*
EAN code:	404702654014
Box color:	Silver



Technical information

Nominal Voltage:	12 V		
Nominal capacity: (EN / 20 hr discharge down to 10.5 V)	C20	70 Ah	
Cold cranking amps: (EN / -18°C U10s ≥ 7.5 V)	760 A		
Group size:	L03		
JIS type:	-		
Short-time angle of inclination:	360°		
Permanent angle of inclination:	up to 90°		
Dimension:	Length 278 mm	Width 175 mm	Ht. w terminal 190 mm
Total battery weight: (approx., filled battery)	20,6 kg		
Layout: (ETN, DIN 72331)	ETN 0		
Terminal: (ETN, DIN 72331)	EN taper post		
Base hold down: (ETN, DIN 72331)	B13		
Degassing:	VRLA (Valve Regulated Lead Acid)		

Technical data

Application:	Start/Stop
Service:	Maintenance-free
Standard charging:	Charging voltage: 14,4 V
	Charging current: 7 A
	Charging pattern: IU
Standards:	DIN EN 60095-1, -2, -4 Lead-acid starter batteries; DIN EN 50342 Lead-acid starter batteries; DIN 41 773, Charger with IU characteristics

*AGM (Absorbent Glass Mat): acid absorbed by micro-fiberglass mats allow higher amounts of energy to be provided